

Canon

EOS

ELAN 7_{NE}
DATE

30 **V** DATE

ELAN 7_{NE}

30 **V**

ELAN 7_N

33 **V**



English



INSTRUCTIONS



Thank you for purchasing a Canon product.

The EOS ELAN 7NE (DATE) / ELAN 7N / 30V (DATE) / 33V is a high-performance, AF single-lens reflex camera with Eye Control* and seven AF points. It is suited for a wide variety of subjects and situations with fully automatic and user-controlled shooting modes.

Read this instruction booklet to familiarize yourself with your new camera before taking pictures.

Also read “Handling Cautions” on page 6 to prevent camera malfunction and damage.

Keep this instruction booklet handy for easy reference.

Before Using Your Camera

- Before an important shoot, be sure to take test shots to make sure the camera operates properly.
- EOS cameras have a lens mount for dedicated operation (autofocusing, exposure control, etc.) with Canon EF lenses. Using a non-Canon lens with an EOS camera may not result in proper camera or lens operation.

Note that the warranty does not cover any camera malfunction or damage occurring with the use of non-Canon products.

Symbols



The Caution symbol alerts you to avoid shooting problems.



The Note symbol gives supplemental information for basic camera operation or picture-taking tips.



The Custom Function symbol indicates that there is a relevant Custom Function. For details, see “Custom Function Settings” on page 85.

*  Model (EOS ELAN 7NE, 30V) only

Contents

Introduction

Handling Cautions	6
Quick Start Guide	8
Nomenclature	10
Conventions Used in this Instructions ...	16

1 Before You Start.....17

Installing the Batteries	18
Checking the Battery Level	19
Mounting and Detaching a Lens	20
Mounting a Lens	20
Detaching the Lens	20
How the Shutter Button Works.....	21
Loading and Unloading Film.....	22
Loading Film	22
Checking the Film Speed	23
Unloading Film	24
Midroll Rewind	24
Dioptric Adjustment	25
Holding the Camera	26

2 Fully Automatic Shooting.....27

Full Auto Mode	28
AF-Assist beam with the Built-in Flash...29	
Programmed Image Control Modes...30	
Portrait	30
Landscape	30
Close-up	30
Sports	31

Night Portrait.....	31
Using Red-eye Reduction	32
Using the Self-timer	33
Using the Eyepiece Cover	34
Imprinting the Date or Time	35
Setting the Date and Time.....	36
Replacing the Date Battery	36

3 AF Modes and Metering Modes...37

Selecting the AF Mode	38
One-Shot AF for Still Subjects.....	39
AI Servo AF for Moving Subjects ...	39
AI Focus AF for Automatic AF	
Mode Switching	40
Selecting an AF Point	41
Basic Procedure for AF Point	
Selection.....	41
Automatic Selection.....	42
Manual Selection.....	42
CAL Eye Control Calibration.....	43
Calibration Procedure.....	43
Eye Control Calibration and	
Operation Tips	46
Intelligent Eye Control	46
Deleting Eye Control Calibration	
Settings	47
Using Eye Control	48
Eye Control Servo AF.....	49
Turning Off Eye Control	49

Focusing Off-Center Subjects.....	50
When Autofocus Fails (Manual Focusing)	51
MF Manual Focusing	51
☉ Metering Modes.....	52

4 User-Controlled Shooting.....53

P Program AE.....	54
Tv Shutter-Priority AE.....	56
Av Aperture-Priority AE	58
Depth-of-field Preview	59
M Manual Exposure	60
DEP Depth-of-field AE	62
Depth-of-field AE with a Manually-Selected AF Point	62
Depth-of-field AE with Eye Control ...	64
Exposure Compensation	67
☐ Auto Exposure Bracketing (AEB) ...	68
Canceling AEB	69
✳ AE Lock.....	70
Bulb Exposures.....	71
☐ Multiple Exposures	72
☐ Selecting the Film Advance Mode ...	73
ISO Setting the ISO Film Speed.....	73
🔇 Silencing the Beeper.....	74
☾ LCD Panel Illumination.....	74
Mirror Lockup.....	75
📶 Wireless Remote Control.....	76
Using the Remote Switch	76

5 Flash Photography.....77

Using the Built-in Flash.....	78
In a Basic Zone Mode	78
In a Creative Zone Mode	78
☐ Flash Exposure Compensation...80	
Using an EOS-dedicated Speedlite...81	
Using an EX-series Speedlite	81
Using an EZ/E/EG/ML/TL-series Speedlite	81

6 Custom Functions (C.Fn)83

C.Fn Setting a Custom Function.....	84
Custom Function Settings.....	85

Reference89

Basic Photography Terms	89
Feature Availability Table	91
AE Lock Effects	92
AF Mode and Film Advance Mode Combination.....	92
Program Line	93
Troubleshooting Guide.....	94
Major Specifications.....	95
Index.....	98

Handling Cautions

Camera Care and Storage

- The camera is a precision instrument. Do not drop it or subject it to physical shock.
- The camera is not waterproof and should not be used in wet conditions or underwater. If the camera gets wet, take it to your nearest Canon dealer as soon as possible. If small amounts of water splash onto the camera, wipe it with a clean dry cloth. If the camera is exposed to salty air, wipe it thoroughly with a slightly damp cloth.
- Do not leave the camera in places prone to excessive heat such as in a car on a sunny day. Excessive heat can cause the camera to malfunction.
- The camera contains precision electronic circuitry. Never attempt to disassemble the camera.
- Use only a blower brush to blow away any dust on the lens, eyepiece, mirror, focusing screen, film compartment, etc. Do not clean the camera body or lens with any cleaner containing an organic solvent. For stubborn dirt, consult your nearest Canon dealer.
- The shutter curtains are extremely thin. Use only a blower to clean them. Be careful not to blow air too forcefully on the shutter curtains. The shutter curtains can be easily deformed or damaged. Also, when loading and unloading film, be careful not to touch the shutter curtains.
- Do not touch the electrical contacts with your fingers. Otherwise corrosion may develop on the contacts, resulting in improper camera operation.
- If the camera is not to be used for an extended period, remove the batteries. Store the camera in a well-ventilated, cool, dry place. During storage, press the shutter button once in a while to release the shutter a few times.
- Avoid storing the camera in a laboratory, cabinet, etc., where corrosive chemicals are present.
- If you have not used the camera for some time or if there is an important shoot, have the camera checked by your Canon dealer beforehand, or check for yourself that the camera components are working properly.

LCD Displays

LCD displays operate more slowly at low temperatures, and may appear dark at high temperatures. The display will return to normal at room temperature.

Batteries

- Before installing the batteries, wipe the battery contacts to remove any fingerprints and smudges. This is to prevent faulty connections and corrosion.
- Never disassemble or recharge the batteries. Also, never store a battery in high-temperature places or short circuit the battery contacts or toss a battery into a fire.
- Although the batteries work well even at low temperatures, battery performance may decline slightly at freezing temperatures. In such a case, keep spare batteries warm in a pocket, etc., and use and warm the batteries alternately.

How Low Battery Levels Affect Camera Operation

On the LCD panel, if the <⏏> icon blinks or it is not displayed, a proper exposure can still be obtained as long as the shutter releases. However, when the battery level is low, the film advance and auto rewind might stop midway or not work at all and the <⏏> icon may blink on the LCD panel. After the batteries are replaced with new ones, film advance will be possible and film rewind can resume by pressing the <⏏> button.

Lens Electrical Contacts

After detaching the lens from the camera, put on the lens caps or put down the lens with the rear end up to avoid scratching the lens surface and electrical contacts.

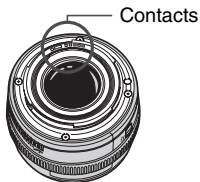

Quick Start Guide

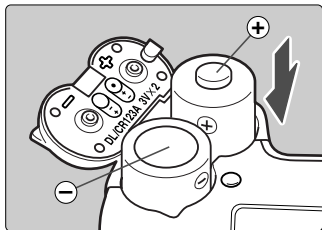

- 1 Install the batteries.**
Refer to the battery orientation diagram on the battery chamber cover, and insert two CR123A lithium batteries as shown. (p.18)

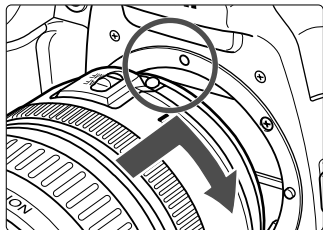

- 2 Attach a lens.**
Align the red dots on the lens and camera and turn the lens as shown by the arrow until it snaps in place. (p.20)

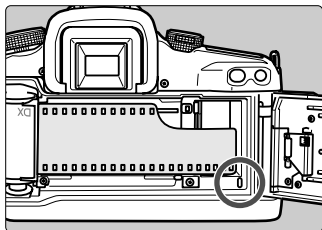

- 5 Load the film.**
Align the edge of the film leader with the orange mark on the camera and close the camera back until it snaps shut. (p.22)
- The film will advance to the first frame.



- 6 Focus the subject.**
Aim the AF points on the main subject and press the shutter button halfway to autofocus. (p.21)
- Under low-light or backlit conditions, the built-in flash will pop-up and fire automatically. (p.78)

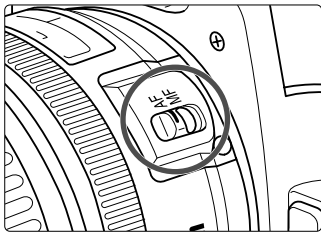

- 3** On the lens, set the focus mode switch to **<AF>**. (p.20)

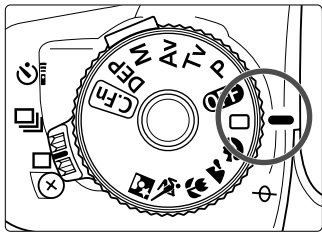

- 4** Turn the Mode Dial to **<□>** (Full Auto). Keep pressing the Mode Dial's lock button while turning the dial. (p.28)

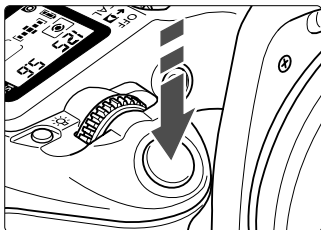

- 7** Take the picture. Press the shutter button completely to take the picture. (p.21)

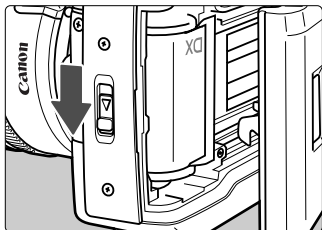

- 8** Unload the film. At the end of the roll, the film rewinds automatically. Open the camera back to remove the film cartridge. (p.24)

Nomenclature

- Reference page numbers are in parentheses.
- The camera controls are indicated as icons in brackets < >.

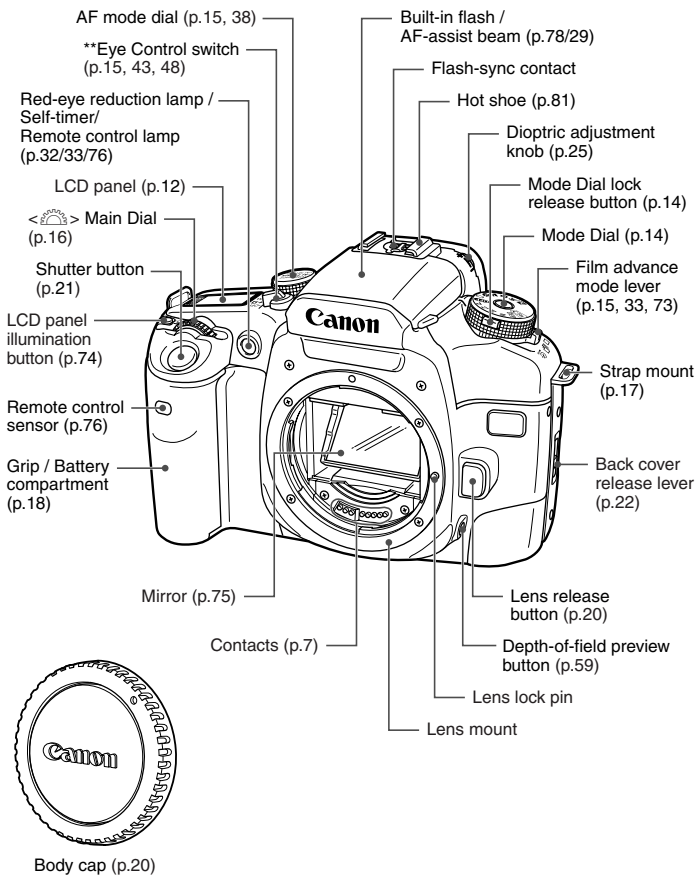

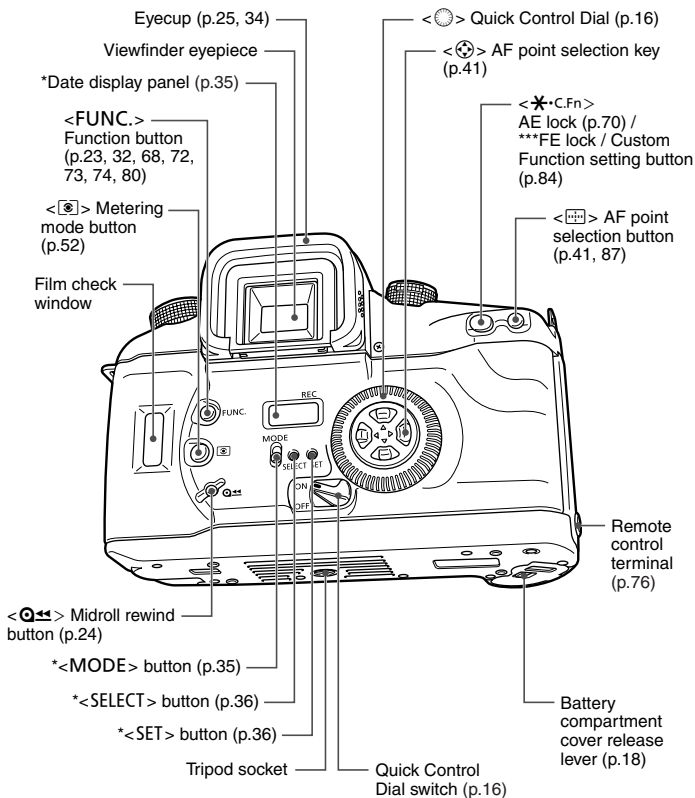

* DATE Model only

**  Model only

*** With an EX-series Speedlite.

Nomenclature

LCD Panel

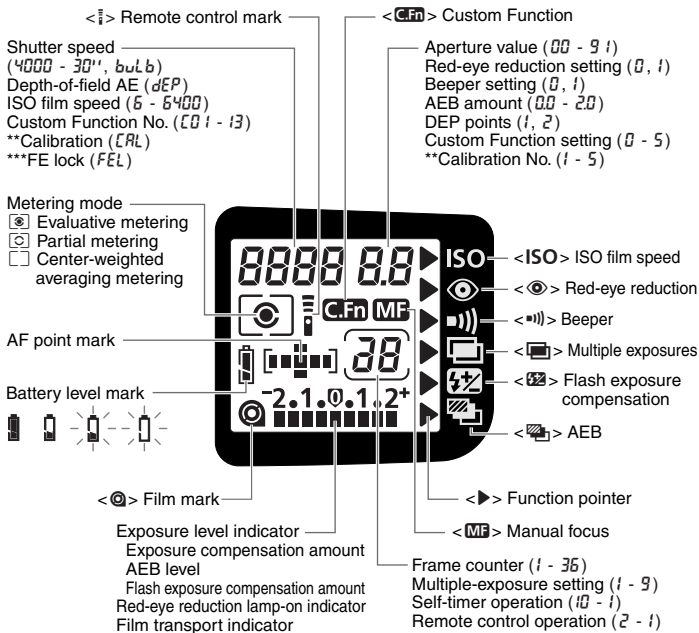

** Model only

*** With an EX-series Speedlite.

• The actual display will show only the applicable items.

Viewfinder Information

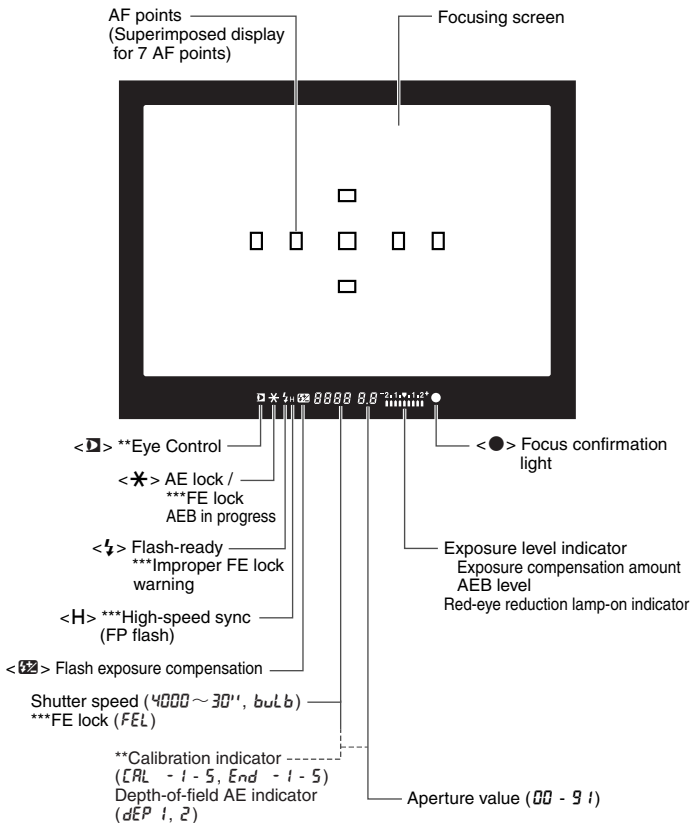

Nomenclature

Mode Dial

- The dial has modes in two zones.
- The dial is locked when it is set to <OFF>. To release the lock, hold down the Mode Dial lock release button and turn the dial.

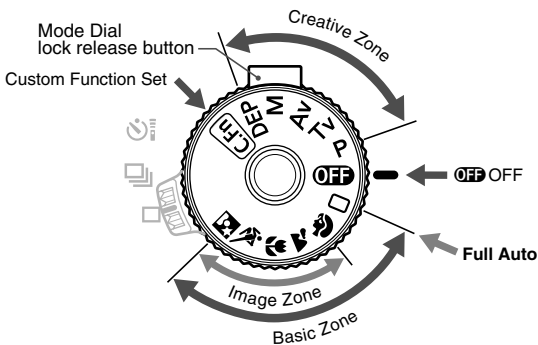

① Basic Zone

Fully automatic mode where the camera takes care of everything.

 : Full Auto (p.28)

Basically, all you do is point and shoot.

Image Zone (p.30)

Fully automatic modes for a particular subject.

 : Portrait

 : Landscape

 : Close-up

 : Sports

 : Night Portrait

② Creative Zone

Semi-automatic and manual modes enable you to take control of the camera to obtain the desired result.

P : Program AE (p.54)

Tv : Shutter-priority AE (p.56)

Av : Aperture-priority AE (p.58)

M : Manual exposure (p.60)

DEP : Depth-of-field AE (p.62)

③ Custom Function Set

C.Fn : Custom Function (p.83)

④ OFF : OFF

AF Mode Dial

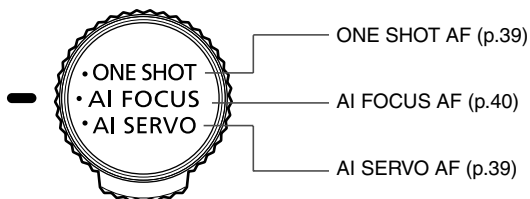

Eye Control Switch (▣ Model only)

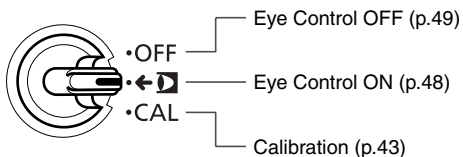

Film Advance Mode Lever

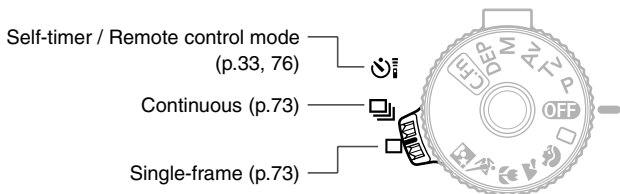

Conventions Used in this Instructions

* This instruction booklet includes Eye Control instructions. Ignore those instructions if your camera EOS ELAN 7N/33V does not have Eye Control.

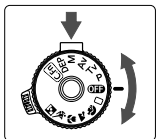

- All the operations described in this booklet assume that the Mode Dial is not set to <OFF>. Before proceeding with any operation, turn the Mode Dial to a picture-taking mode by pressing the lock button and turning the dial.



- The <gear> icon indicates the Main Dial.



- The <dial with dot> icon indicates the Quick Control Dial.



- The <switch> icon indicates the Quick Control Dial switch. Operations with the <dial with dot> dial assume that the <switch> switch is already set to <ON>. Be sure it is set to <ON>.



- The <directional pad> icon indicates the AF point selection key.

- The camera control icons and markings used in this booklet correspond to the actual icons and markings found on the camera.
- Reference page numbers are in parentheses.
- The ★ symbol indicates that the respective feature can be used only in Creative Zone modes (P, Tv, Av, M, DEP).
- In this instruction booklet, a Canon EF 28-105mm f/3.5-4.5 lens is used for example purposes.
- The procedures explained in this booklet assume that the Custom Functions are set to the default settings.
- The (4) and (6) icons indicate that the respective function remains in effect for 4 and 6 sec. respectively after the button is released.

1

Before You Start

This chapter explains a few preliminary steps and basic camera operations.

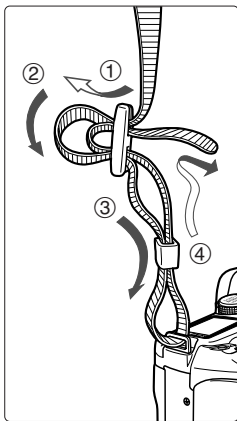

Attaching the Strap

Pass the end of the strap through the camera's strap mount from the bottom. Then pass it through the strap's buckle as shown in the illustration. Pull the strap to make sure it does not slip out of the buckle.

- The eyepiece cover is also attached to the strap. (p.34)

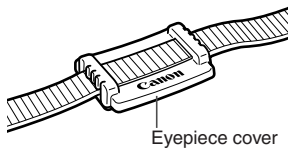

Installing the Batteries

* In the Americas, batteries are not included with the camera.

The camera uses two lithium CR123A (or DL123A) batteries.

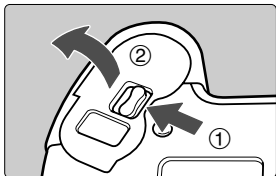

1 Open the battery compartment cover.

- Slide the release lever as shown by the arrow and open the cover.

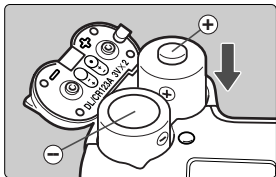

2 Install the batteries.

- Make sure the battery contacts (+ and -) are properly oriented as shown.
- Do not mix old and new batteries.

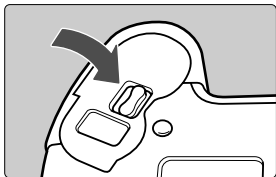

3 Close the battery compartment cover.

- Press the cover until it snaps shut.

 For places where CR123A (or DL123A) batteries may not be easily available, take spare batteries with you. Also carry spare batteries for extended shooting sessions.

Checking the Battery Level

Check the battery level after replacing the batteries and before using the camera.

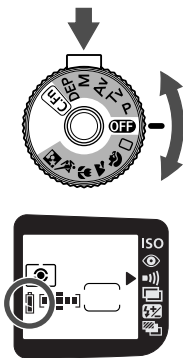



Turn the Mode Dial to a shooting mode.

- Hold down the dial's lock release button while turning the dial.
- ▶ The camera will then turn on and the LCD panel will display one of the following battery level mark:

 : Battery level OK.

 : The battery level is low. Keep spare batteries handy.

 : The batteries will soon be completely exhausted.

 : Replace the batteries.

Battery Life

(With 24-ex. rolls)

Temperature	0% Flash Use	50% Flash Use	100% Flash Use
At 20°C	125 (115) rolls	38 (33) rolls	19 (17) rolls
At -20°C	70 (65) rolls	20 (19) rolls	10 (9) rolls

- The battery life shown above is based on Canon's testing conditions with new batteries.
- Figures in parentheses apply when the Eye Control switch is <ON>.



- If nothing is displayed on the LCD panel, the batteries may have been installed incorrectly. Take out the batteries and install correctly.
- If you often press the shutter button halfway for a prolonged period or just autofocus without taking a picture, the battery life will be affected.
- When not using the camera, set the Mode Dial to <OFF>.

Mounting and Detaching a Lens

Mounting a Lens

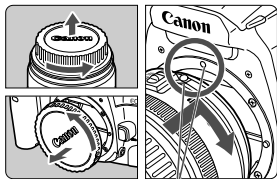

Red dots

- 1 Remove the caps.**
 - Remove the rear lens cap and the camera body cap.
- 2 Mount the lens.**
 - Align the red dots on the lens and camera and turn the lens as shown by the arrow until it snaps in place.
- 3 On the lens, set the focus mode switch to <AF>.**
 - If the focus mode switch is set to <MF>, autofocus will not operate.
- 4 Remove the front lens cap.**

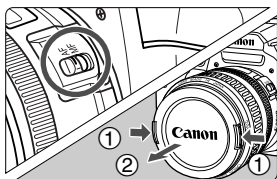

Detaching the Lens

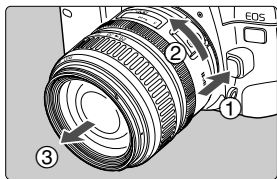

- While pressing the lens release button, turn the lens as shown by the arrow.**
- Turn the lens until it stops, then detach it.



- Keep the removed caps where you will not lose them.
- <AF> stands for “Auto Focus,” and <MF> stands for “Manual Focus.”
- An EF-S lens cannot be attached to the camera.

How the Shutter Button Works

The shutter button has two stages. You can press it down halfway or fully. The two levels of shutter button operation are as follows:

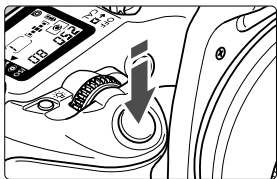

When it is pressed halfway:

- ▶ Pressing the shutter button down halfway activates autofocus (AF) and automatic exposure (AE) and the shutter speed and aperture value are set.
- ▶ The exposure (the combination of shutter speed and aperture value) appears on the LCD panel and in the viewfinder (◉4).

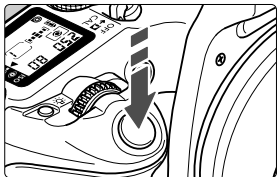

When it is pressed fully:

- ▶ The shutter is released to take the picture and the film advances by one frame.

⚠ If an Extender (sold separately) is used and the maximum aperture (the lowest f/number) of the lens becomes smaller than f/5.6, autofocusing will not operate.

- After pressing the shutter button halfway, wait a moment before pressing it completely to take the picture. If you press the shutter button completely at one stroke or right after pressing it halfway, it will take a moment before the picture is taken.
- Camera movement during the moment of exposure is called camera shake. Camera shake can cause blurred pictures. To prevent blurred pictures due to camera shake:
 - Hold the camera steady.
 - Use your finger tip to touch the shutter button, grasp the camera with your entire right hand, then press the shutter button gently.
- If the AF Mode Dial has been set to <AI SERVO>, the focus confirmation light <●> will not light.
- If the AF Mode Dial has been set to <AI SERVO> and automatic AF point selection is set (p.42), the AF point will not flash in red.

Ⓞ Loading and Unloading Film

Loading Film

When you load the film, it advances automatically to the first frame. With DX-coded film, the camera automatically sets the film's ISO speed.

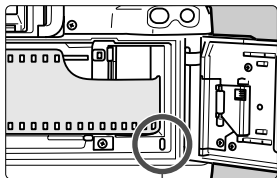
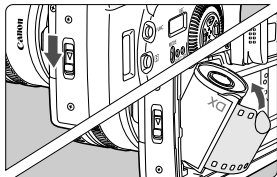

Orange mark

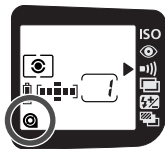
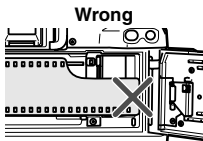

- 1 Turn the Mode Dial to any setting except <OFF>.**
 - Hold down the dial's lock release button while turning the dial.
- 2 Open the back cover.**
 - Slide down the back cover release lever and open the back.
- 3 Insert the film cartridge at a slight angle.**
- 4 Pull the edge of the film leader to the orange mark on the camera.**
 - Hold down the film cartridge while pulling out the film leader.
 - If you pull out the film leader too much, rewind it back into the film cartridge.
- 5 Close the back cover.**
 - Close the back cover until it snaps shut.
 - ▶ The film will advance to frame 1 automatically.
 - ▶ While the film advances, the ISO speed will be displayed on the LCD panel.
 - ▶ When the initial film advance ends, the <Ⓞ> icon and frame counter of "1" will be displayed on the LCD panel.

- The shutter curtains have been manufactured with very high precision. Never touch them with your fingers. When loading film, do not touch or damage the curtains with your fingers or film.
- In hot and humid environments, do not remove the film packaging until you are ready to load the film.
- Infrared film cannot be used with this camera.

If the film is not loaded properly, the <Ⓢ> icon will blink on the LCD panel and the shutter will not work. Reload the film properly.

Checking the Film Speed

The camera reads the film cartridge's DX code and sets the film speed automatically within ISO 25 - 5000.

- Set the Mode Dial to a Creative Zone mode.

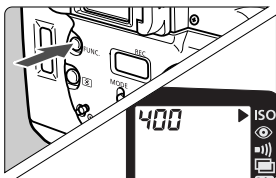

Move the <▶> arrow to the <ISO> icon.

- Look at the LCD panel and press the <FUNC.> button to move the arrow.
(Ⓢ6)
- ▶ The current film speed is displayed.

If you want to set a film speed different from the DX-coded film speed or if the film cartridge is not DX-coded, see “Setting the ISO Film Speed” on page 73.

C.Fn C.Fn-03-1 can prevent the film speed from being set automatically with the DX code. (p.85)

Ⓞ Loading and Unloading Film

Unloading Film

After the film's last frame is exposed, the camera rewinds the film automatically.



- ▶ During film rewind, the LCD panel will indicate the film rewinding and the frame count will count down.
- ▶ The film rewind stops automatically.
- Check that the <Ⓞ> icon is blinking, then open the camera back and take out the film.

ⓄⓂ Midroll Rewind

To rewind the film in midroll, follow the procedure below.

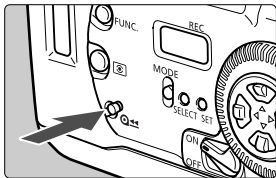

Press the <ⓄⓂ> button.

- ▶ Film rewind will begin.
- ▶ The film rewind stops automatically.
- Check that the <Ⓞ> icon is blinking, then open the camera back and take out the film.



 During film rewind, pressing the <ⓄⓂ> button toggles between high-speed and low-speed (silent) rewind.

C.Fn

- C.Fn-01-1 can make the film rewind faster. (p.85)
- C.Fn-02-1 can leave out the film leader when the film rewind ends. (p.85)

Dioptric Adjustment

By adjusting the diopter, eyeglass wearers will not need their eyeglasses to see a sharp viewfinder image. The camera's adjustable dioptic range is -2.5 to $+0.5$ dpt.

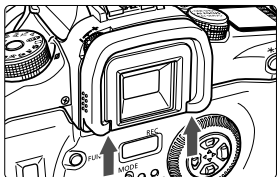

1 Remove the eyecup.

- While grasping both sides at the bottom of the eyecup, slide it upward to remove.

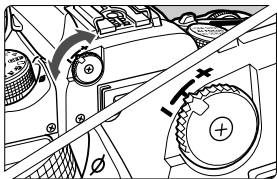

2 Turn the dioptic adjustment knob.

- Turn the knob left or right so that the AF points in the viewfinder look sharp.
- The illustration shows the knob at the standard setting (-1 dpt).

3 Reattach the eyecup.

 If the dioptic adjustment knob still cannot make the viewfinder look clear, use a Dioptic Adjustment Lens Ed (10 types sold separately).

Holding the Camera

To avoid taking blurred pictures, hold the camera steady to minimize camera shake.

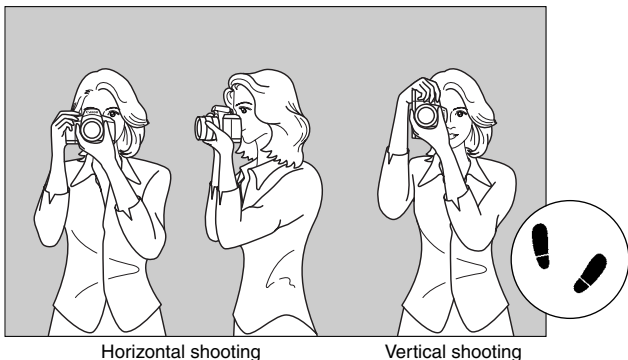

- Firmly grasp the camera grip with your right hand, and press your both elbows lightly against your body.
- Hold the lens at the bottom with your left hand.
- Press the camera against your face and look through the viewfinder.
- To maintain a stable stance, place one foot in front of the other instead of lining up both feet.



The camera automatically senses whether it is in the horizontal or vertical position. The camera orientation sensor will make a small sound when you switch to vertical or horizontal shooting.

2

Fully Automatic Shooting

This chapter describes how to use the camera's Basic Zone modes <□> <👤> <🏔️> <🌻> <🏹> <🏠> for quick and easy shooting. In these modes, all you do is point and shoot. Also, these modes override the camera's <🌅> <🕒> and AF Mode dials, film advance mode lever (except <👉>), and buttons (except <FUNC.> <🔍> and the shutter button). This is to prevent spoiled shots caused by accidental operation of camera controls.

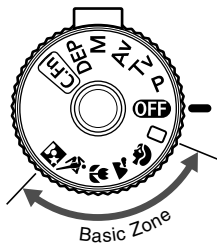

Turn the Mode Dial to <□>, <👤>, <🏔️>, <🌻>, <🏹>, or <🏠>.

- The picture-taking procedure is the same as with the “<□> Full Auto mode” on page 28.
- The settings automatically set by the Basic Zone modes are shown in the “Feature Availability Table” on page 91.

□ Full Auto Mode

All you do is point the camera and press the shutter button. Everything is automatic so it is easy to photograph any subject. With seven AF points to focus the subject, you just point and shoot.



1 Turn the Mode Dial to <□>.



AF point

2 Aim any of the AF points on the subject.

- The main subject, as determined by the camera, will be focused by one of the AF points.
- To focus a subject not covered by any of the AF points, see “Focusing Off-Center Subjects” on page 50.

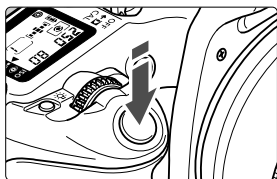

3 Focus the subject.

- Press the shutter button halfway to focus.
 - ▶ When necessary, the built-in flash will pop up automatically.
 - ▶ The AF point that achieves focus will flash in red. The beeper will also sound and the focus confirmation light <●> in the viewfinder will light.

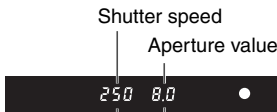

Shutter speed

Aperture value

4 Check the exposure setting.

- ▶ The shutter speed and aperture value will be set automatically and displayed in the viewfinder and on the LCD panel. (4)

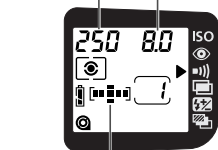



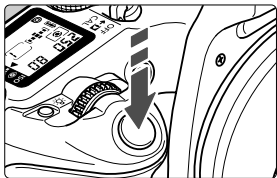

AF point mark



5 Take the picture.



- Compose the shot and press the shutter button fully.

- If you want to zoom, do it before focusing. Turning the zooming ring after achieving focus may throw off the focus.
- If the built-in flash's pop-up operation is obstructed, the  icon will blink on the LCD panel. Press the shutter button halfway to resolve the problem.

- When focus is achieved, the autofocus and auto exposure setting will also be locked.
- If the focus confirmation light  blinks, the picture cannot be taken. (p.51)
- Out of the seven AF points, the one covering the closest subject is selected automatically to achieve focus.
- If multiple AF points flash in red simultaneously, it indicates that all those AF points have achieved focus.
- In the Basic Zone modes (except  > ), the built-in flash will pop up and fire automatically in low-light or backlit conditions. To retract the flash, push it back down.

AF-Assist beam with the Built-in Flash

Under low-light conditions, the built-in flash fires a brief burst of flashes when you press the shutter button halfway. This is to illuminate the subject to enable easier autofocusing.

- The AF-assist beam does not function in the  >  modes.
- The built-in flash's AF-assist beam is effective up to about 4 meters/13.1 feet.
- In the Creative Zone modes, if the built-in flash is popped up, the AF-assist light will emitted when necessary.

Programmed Image Control Modes

Select a shooting mode to suit the target subject, and the camera will be set to obtain the best results.



Portrait



This mode blurs the background to make the human subject stand out.

- Holding down the shutter button executes continuous shooting.
- For better background blur, use a telephoto lens and fill the frame with the subject or have the subject stand closer to the camera.
- ▶ This automatically sets the AF mode to <ONE SHOT>, the film advance mode to <[]>, and the metering mode to <[]>.



Landscape



This is for wide scenic views, night scenes, etc.

- Using a wide-angle lens will further enhance the depth and breadth of the picture.
- ▶ This automatically sets the AF mode to <ONE SHOT>, the film advance mode to <[]> (single-frame shooting), and the metering mode to <[]>.



Close-up



Use this mode to take close-up shots of flowers, insects, etc.

- As much as possible, focus the subject at the lens' closest focusing distance.
- To obtain a larger magnification, use the telephoto end of a zoom lens.
- For serious close-up shots, optional EOS-dedicated macro lenses are recommended.
- ▶ This automatically sets the AF mode to <ONE SHOT>, the film advance mode to <[]> (single-frame shooting), and the metering mode to <[]>.



Sports



This is for fast-moving subjects when you want to freeze the action.

- The camera will first track the subject with the center AF point. Focus tracking will then continue with any of the seven AF points covering the subject.
- While you hold down the shutter button, focusing will continue for continuous shooting.
- Using a telephoto lens and ISO 400 or higher speed film is recommended.
- The focus confirmation light will not light even when focus is achieved.
- ▶ This automatically sets the AF mode to <AI SERVO>, the film advance mode to <[M]>, and the metering mode to <[M]>.



Night Portrait



This mode is for taking pictures of people at twilight or at night. The flash illuminates the subject while a slow sync speed obtains a natural-looking exposure of the background.

- If you want to photograph only a night scene (without people), use the <[N]> mode instead.
- Tell the subject to keep still even after the flash fires.
- ▶ This automatically sets the AF mode to <ONE SHOT>, the film advance mode to <[S]> (single-frame shooting), and the metering mode to <[M]>.

- A blinking shutter speed indicates that the shutter speed is too slow to prevent a blurred picture caused by camera shake. Hold the camera steady and press the shutter button smoothly, or use a tripod. (The shutter speed indicator still blinks when you use a tripod, but camera shake will not be a problem.)
- In the <[N]> mode, use a tripod to prevent camera shake.

👁 Using Red-eye Reduction (with the built-in flash)

When flash is used in a low-light environment, the subject's eyes may come out red in the photograph. "Red eye" happens when the light from the flash reflects off the retina of the eyes. The camera's red-eye reduction feature turns on the red-eye reduction lamp to shine a gentle light into the subject's eyes to narrow the pupil diameter or iris. A smaller pupil reduces the chances of red eye from occurring. Red-eye reduction can be set in any shooting mode except <👤> <👤>.

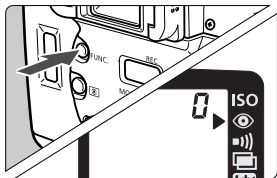

1 Move the <▶> arrow to the <👁> icon on the LCD panel.

- Look at the LCD panel and press the <FUNC.> button to move the arrow. (🕒6)

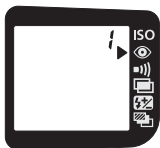

2 Turn the <⚙> dial to set "I" on the LCD panel.

- Press the shutter button halfway to return to normal camera operation.
- To cancel red-eye reduction, set "I" on the LCD panel.



- When you press the shutter button halfway, the red-eye reduction lamp-on indicator will appear in viewfinder and on the LCD panel.
- Red-eye reduction will not work unless the subject looks at the red-eye reduction lamp. Tell the subject to look at the lamp.
- For maximum effectiveness, press the shutter button fully after the red-eye reduction lamp turns off (after 1.5 sec.).
- You can take a picture even while the red-eye reduction lamp is lit.
- The effectiveness of red-eye reduction varies depending on the subject.
- To further increase the effectiveness of red-eye reduction, go to a brighter environment or move closer to the subject.



Red-eye reduction lamp-on indicator

Using the Self-timer

You can use self-timer in any Basic Zone mode or Creative Zone mode. We recommend using a tripod when you use the self-timer.

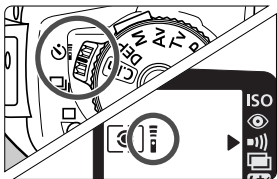

1 Set the film advance mode lever to $\langle \text{self-timer icon} \rangle$.

- ▶ The $\langle \text{self-timer icon} \rangle$ icon will be displayed on the LCD panel.

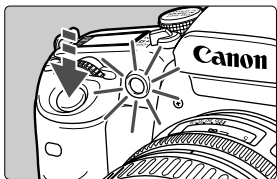

2 Take the picture.

- The picture-taking procedure is the same as with the $\langle \text{Full Auto mode icon} \rangle$ Full Auto mode on page 28.
- Look through the viewfinder and press the shutter button fully to start the self-timer.
 - ▶ The picture will be taken about 10 sec. later.
During the first 8 seconds, the beeper beeps slowly and the red-eye reduction lamp flashes.
During the final 2 seconds, the beeper beeps faster and the red-eye reduction lamp stays lit.
- ▶ During the self-timer operation, the LCD panel counts down the seconds until the picture is taken.

⚠ Do not stand in front of the camera when you press the shutter button to start the self-timer. Doing so prevents the camera from focusing the subject.

- 📄 To cancel the self-timer after it starts, set the film advance mode lever to $\langle \text{single-frame shooting icon} \rangle$ or $\langle \text{continuous shooting icon} \rangle$.
- When using the self-timer to take a picture of only yourself, first lock the focus (p.50) on an object at the same distance where you will be in the picture.
- The self-timer beeper can be silenced. (p.74)

Using the Eyepiece Cover

When using the self-timer or optional wireless remote control, you should use the eyepiece cover (p.17) to prevent stray light from entering the eyepiece and affecting the exposure reading.

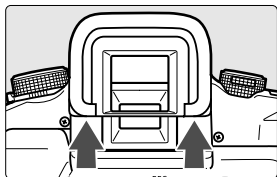

1 Remove the eyecup from the eyepiece.

- Push up both sides at the bottom of the eyecup.

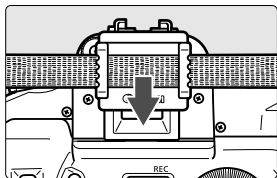

2 Attach the eyepiece cover.

- The eyepiece cover is attached to the strap.
- Slide the eyepiece cover down into the eyepiece groove to attach it.

Imprinting the Date or Time (DATE Model only)



The camera has a date feature with an automatic calendar to 2019. It can imprint the date or time on the photograph as shown in the left photo.

The date or time can be imprinted in any shooting mode.

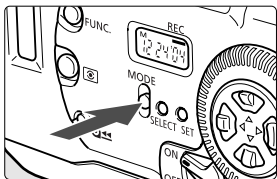

Press the <MODE> button.

► Each time the button is pressed, the imprinting format changes in the following sequence as shown on the quartz date display panel:

Month, day, year	M 12 24 04	(Dec. 24, 2004)
Day, month, year	24 M 12 04	(24 Dec. 2004)
Year, month, day	04 M 12 24	(2004 Dec. 24)
Day, hour, minute	24 16:45	(24th 16:45)
Hyphens	- - - - -	(Blank)

- <M> is displayed above the month.
- When a picture is taken, the bar <—> will blink to indicate that the date or time has been imprinted.

Imprinting the Date or Time (DATE Model only)

Setting the Date and Time

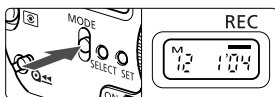

1 Select the date or time display.

- Press the <MODE> button.

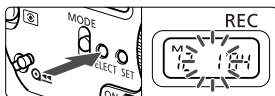

2 Select the digit to be set.

- Press the <SELECT> button until the digit blinks.
 - ▶ Each time you press the button, the settable digit will change as follows: Year → month → day. Or hour → minute → “:”



3 Set the correct number.

- Keep pressing the <SET> button until the correct number appears.
- Repeat steps 2 and 3 until all the date and time digits are set correctly.

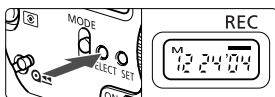

4 Finalize the setting.

- Keep pressing the <SELECT> button until no digits blink.
- If “:” is blinking and you press <SELECT>, the seconds will be reset to 0.

Replacing the Date Battery

When the date/time on the imprinted photograph looks faded, replace the CR2025 lithium battery as follows. Battery life is about 3 years.

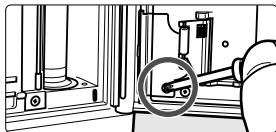

1 Remove the battery chamber cover.

- Open the camera back and loosen the screw as shown in the illustration.

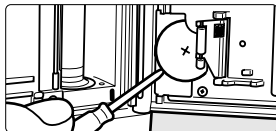

2 Take out the battery.

3 Insert a new battery.

- The battery's positive contact (+) must face up.

4 Reattach the battery chamber cover.

- Set the correct date and time.

3

AF Modes and Metering Modes

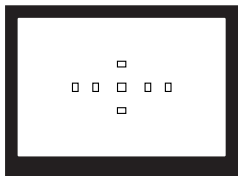

The viewfinder has seven AF points. You can select the AF point closest to the subject to make it easier and faster to compose the picture. You can also select the AF mode to suit the subject or shooting conditions.



Evaluative, partial, and center-weighted averaging metering modes are provided. Set the metering mode to suit shooting conditions and obtain the desired exposure.

- The ★ symbol indicates that the respective feature can be used only in Creative Zone modes (P, Tv, Av, M, DEP).

Selecting the AF Mode★

The AF mode is the autofocusing method. The camera has three AF modes: 1. One Shot AF for still subjects, 2. AI Servo AF for moving subjects, and 3. AI Focus AF that switches automatically from One-Shot AF to AI Servo AF if the subject starts to move.

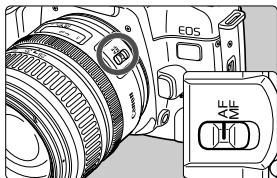

1 Set the lens focus mode switch to <AF>.

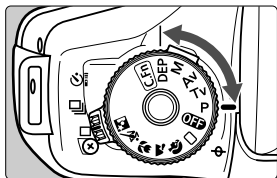

2 Set the Mode Dial to a Creative Zone mode.

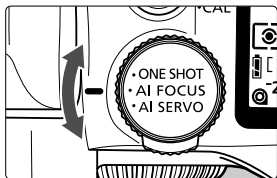

3 Turn the AF mode dial to select the AF mode.

ONE SHOT : One-Shot AF

AI FOCUS : AI Focus AF

AI SERVO : AI Servo AF

One-Shot AF for Still Subjects



AF point

Focus
confirmation light



Pressing the shutter button halfway activates AF operation and achieves focus once.

- ▶ The AF point which achieves focus will flash briefly and the focus confirmation light in the viewfinder will light at the same time.
- ▶ With evaluative metering, the exposure setting (shutter speed and aperture value) will be set when focus is achieved. The exposure setting and focus will be locked as long as the shutter button is pressed halfway. (p.50) You can then recompose the shot while retaining the exposure setting and point of focus.



If focus has not been achieved, the focus confirmation light <●> in the viewfinder will blink. In this case, you cannot take a picture even when you press the shutter button fully. Recompose the shot and try and focus again. Also see “When Autofocus Fails” (p.51).

AI Servo AF for Moving Subjects



While you press the shutter button halfway, the camera focuses continuously

- This AF mode suits moving subjects when the focusing distance keeps changing.
- ▶ With predictive AF*, the camera can also focus track a subject which steadily approaches or retreats from the camera.
- ▶ The exposure settings are set immediately before the picture is taken.

Selecting the AF Mode★

- When focus is achieved, the focus confirmation light <●> in the viewfinder will not light and the beeper will not sound.
- If the focus confirmation light <●> in the viewfinder blinks, it means focus has not been achieved.
- Focus lock cannot be used.

* Predictive AF

If the subject approaches or retreats from the camera at a constant rate, the camera tracks the subject and predicts the focusing distance immediately before the picture is taken. This is for obtaining correct focus at the moment of exposure.

- When the AF point selection is automatic, the camera first uses the center AF point to focus. If the subject moves away from the center AF point, focus tracking continues as long as the subject is covered by another AF point. The active AF point will not flash in red.
- With a manually selected AF point, the selected AF point is used for predictive AF.
- In the Eye Control mode, Eye Control Servo AF (p.49) will be used. As long as one of the AF points cover the moving subject, predictive AF will continue to track the subject as you follow it with your eye.

C.Fn With C.Fn-04-2, holding down the <★·C.Fn> button will temporarily stop the AF operation in the AI Servo AF mode. (p.85)

AI Focus AF for Automatic AF Mode Switching

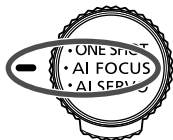

The AI Focus AF mode switches automatically from One-Shot AF to AI Servo AF if the subject starts to move. If focus is achieved in the One-Shot AF mode and the subject starts to move continuously, the camera will detect the movement and switch automatically to AI Servo AF to focus track the subject.

Selecting an AF Point★

The AF point is used for focusing. The AF point can be selected automatically by the camera or manually by you. **In the Basic Zone modes and <DEP> mode, the AF point selection is automatic only. In the <P> <Tv> <Av> <M> modes, the AF point can be selected either automatically or manually.**

• Automatic AF Point Selection

The camera selects the AF point automatically to match the subject.

• Manual AF Point Selection

You can select any of the seven AF points manually. This is best when you want to focus a particular subject, or to compose a particular shot quickly.

• Eye Control (p.43 - 49)

Select one of the seven AF points by looking at it.

Basic Procedure for AF Point Selection

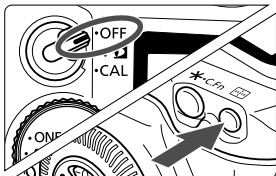

1 Set the Eye Control switch to <OFF>.

2 Press the  button. (6)

▶ The current AF point will be indicated on the LCD panel and in the viewfinder.

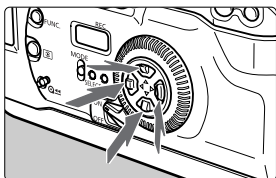

3 Select the desired AF point.

• Look at the viewfinder or LCD panel and press the  key.

▶ Press the  keys on the left, right, top, or bottom to select the left, right, top, or bottom AF point respectively.

• To return to shooting, press the shutter button halfway or press the  button again.



If you use an external, EOS-dedicated Speedlite and focus cannot be achieved with the AF-assist beam, select the center AF point.

Selecting an AF Point★

Automatic Selection



Display all AF points in red.



- When you try to select an AF point beyond a peripheral AF point, automatic focusing selection will be set.

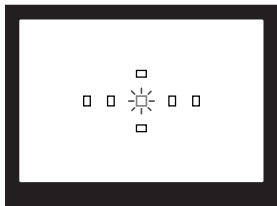

Manual Selection



Display the desired AF point in red.

- See the diagram on the left on how the AF point selection changes with the  button.
- When you press the  button to switch from automatic AF point selection to manual AF point selection, the selection will start with the center AF point.







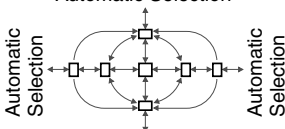

Center AF point selected

Automatic Selection



Automatic Selection

C.Fn

- C.Fn-10-1 can disable the AF point from flashing in red. (p.87)
- C.Fn-11-1 enables you to select a AF point directly with the  keys without having to press the  button first. (p.87)
- C.Fn-11-2 enables you to select a AF point with the  and  dials instead of the  keys. (p.87)
- C.Fn-12-1 can make the  button switch to the center AF point. (p.88)

CAL Eye Control Calibration (D Model only)

With Eye Control, the camera detects which AF point your eye is looking at. That AF point is then selected and used to focus the subject.

Calibration Procedure

Before using Eye Control, you must calibrate the camera so that it can correctly detect the movements of your eye looking through the eyepiece. To calibrate it, look at the blinking AF point, then press the shutter button. You must calibrate it for both the horizontal and vertical camera orientations. The camera can save up to five calibration settings.

- **To maximize the calibration precision, read “Eye Control Calibration and Operation Tips” on page 46.**
 - Before starting, complete any necessary dioptic adjustment. (p.25)
 - While calibrating the camera, do not take your eye off the eyepiece.
- * “CAL” stands for calibration.

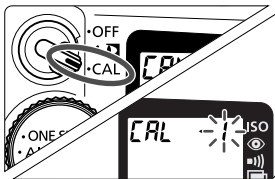

1 Set the Eye Control switch to <CAL>.

- ▶ “CAL” and the CAL No. are displayed on the LCD panel.
- Blinking number:
Indicates unregistered calibration.
- Non-blinking number:
Indicates registered calibration.

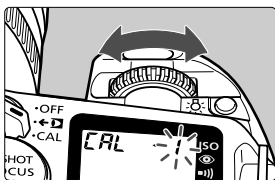

2 Select a blinking CAL No.

- Turn the <mode dial> to select a number.
- If there is no blinking CAL No., see “Deleting Eye Control Calibration Settings” on page 47.

3 Hold the camera horizontally and look at the viewfinder.

CAL Eye Control Calibration (D Model only)

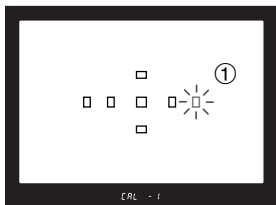

4 Keep looking at the blinking AF point in the viewfinder and press the shutter button.

- The right-most AF point will blink first. While looking at the blinking AF point, press the shutter button.
- ▶ The AF point will stop blinking and stay lit. The beeper will sound at the same time.
- During this calibration procedure, pressing the shutter button completely will not take a picture.

5 Let go of the shutter button.

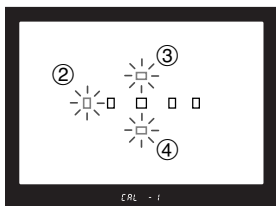

6 Repeat steps 4 and 5.

- ▶ The AF point will blink in the following sequence: ② → ③ → ④.

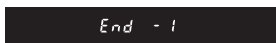

7 Check the viewfinder display.

- ▶ When the calibration is completed, the CAL No. will stop blinking and “End” will be displayed.

8 Hold the camera vertically and look at the viewfinder.

- Calibrate vertically under the same CAL No.
- You can hold the camera vertically with the grip pointing up or down.

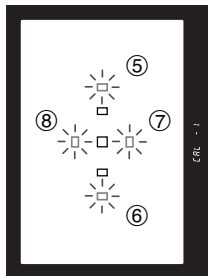

9 While looking at the blinking AF point, press the shutter button.

- Follow steps 4 to 6.
- ▶ The AF point will blink in the following sequence: ⑤ → ⑥ → ⑦ → ⑧.

End - 1

10 Check the viewfinder display.

- ▶ When the calibration is completed, the CAL No. will stop blinking and “End” will be displayed.

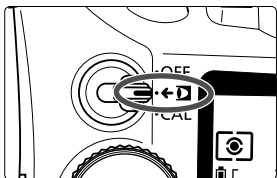

11 Set the Eye Control switch to <←▶>.

- This completes the calibration procedure, and you can now use Eye Control (p.48) to take pictures.

⚠ If the camera does not detect your eye movement properly during the calibration, the beeper will sound and the CAL No. will blink on the LCD panel. In such a case, press the shutter button and start from step 3.

- If you do the calibration procedure only for the horizontal orientation, Eye Control during vertical picture-taking might not be so accurate. Be sure to also complete the calibration procedure for the vertical orientation.
- If you interrupt the calibration procedure, wait until the AF point in the viewfinder stops blinking, then start over from step 3.
- If the calibration does not go well, see “Eye Control Calibration Operation Tips” (p.46).
- If the beeper setting (p.74) is set to “0”, the beeper will not sound.

Eye Control Calibration and Operation Tips

- Hold the camera as you always do while looking through the viewfinder.
- Look through the viewfinder so you can see all four corners of the viewfinder.
- Avoid squinting or blinking your eye.
- When using Eye Control, look through the eyepiece in the same way you did during the calibration.
- During the calibration procedure, keep looking (without moving your eye) at the blinking AF point until it lights and the beeper sounds.
- Keep both eyes open while looking through the viewfinder.
- If you wear eyeglasses, wear them properly without having them slide down your nose.

Eye Control calibration and operation might not be possible in the following cases:

- When you wear bifocal eyeglasses or hard contact lenses.
- You wear mirror-type sunglasses or other specially-coated glasses.
- Your eye is too far away from the eyepiece due to eyeglasses, etc.
- Your eye is too close to the viewfinder.

Intelligent Eye Control

You can repeat the calibration procedure under different conditions such as when you are outdoors, indoors, or at night. The camera can save these additional calibration settings under the same CAL No. By accumulating more calibration settings, the camera can provide more precise Eye Control.



Two or more users must not share the same CAL No. Each user should have his or her own CAL No. If necessary, delete the calibration settings saved under another CAL No. to store another user's calibration settings. (p.47)

Deleting Eye Control Calibration Settings

If you want to save new calibration settings under a CAL No. that already has calibration settings, follow the procedure below to first delete the previous calibration settings. You can then do the calibration procedure and save the new calibration settings under that CAL No.

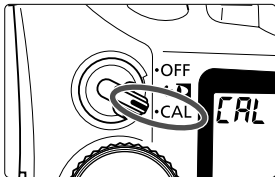

- 1 Set the Eye Control switch to <CAL>.**

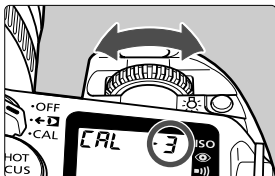

- 2 Select the CAL No. whose calibration settings are to be deleted.**

- Select a non-blinking CAL No.

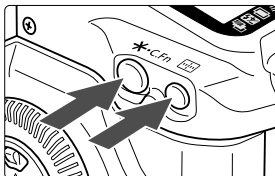

- 3 Press the <*C.Fn> button and <CAL> button simultaneously.**

- ▶ The CAL No. will start blinking to indicate that the calibration settings have been deleted.



◀▶ Using Eye Control (▶ Model only)

With Eye Control, you just look at the AF point where you want to focus.

- Eye Control can be used in all shooting modes except <□> (Full Auto).
- In the <□> (Full Auto) mode, Eye Control information is also added to the automatic AF point selection program for more precise automatic AF point selection.

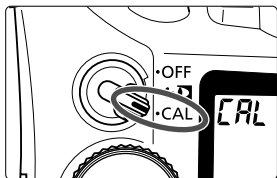

- 1 Set the Eye Control switch to <CAL>.**

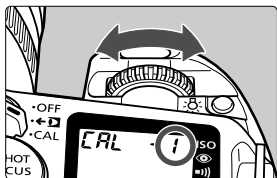

- 2 Select the CAL No.**
 - Turn the <⚙> dial to select your CAL No.
Non-blinking number:
Indicates registered calibration.
Blinking number:
Indicates unregistered calibration.

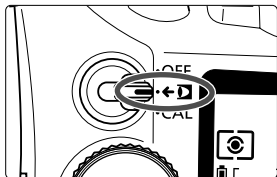

- 3 Set the Eye Control switch to <▶▶>.**

- 4 Select a shooting mode.**
 - Turn the Mode Dial to select the desired shooting mode.

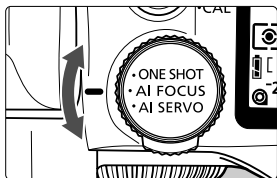

- 5 Turn the AF mode dial to select the AF mode.**

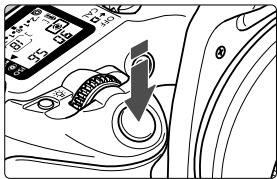

6 Keep looking at the focusing point you want to select and press the shutter button halfway.

- ▶ The <D> icon lights in the viewfinder.
- ▶ The AF point you look at will flash in red and focus the subject.

7 Take the picture.

- If the camera fails to detect which AF point you are looking at, the <D> icon in the viewfinder will blink and automatic AF point selection will take effect.
- If Eye Control does not work well, check if you are using the correct CAL No. and see “Eye Control Calibration and Operation Tips” on page 46.

Eye Control Servo AF

When you use Eye Control in the AI Servo AF mode (or AI Focus AF set to AI Servo AF), you can focus a moving subject continuously just by looking at it. This is called Eye Control Servo AF.

If the subject focused with Eye Control starts to move, you can continue to focus-track the subject with your eye by looking at the next AF point covering the subject while holding down the shutter button halfway.

Turning Off Eye Control

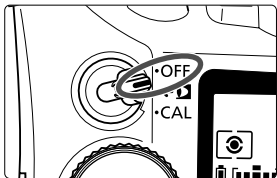

Turn the Eye Control switch to <OFF>. The AF point can then be selected automatically or manually.

Focusing Off-Center Subjects

After achieving focus, you can lock the focus on a subject and recompose the shot. This is called “**focus lock**.”

Focus lock works when the AF mode is set to One Shot AF.

1 Set the camera to a Creative Zone mode.

2 Select the desired AF point.

3 Focus the subject.



- Aim the AF point on the subject, then press the shutter button halfway.



4 Keep pressing the shutter button halfway and recompose the picture as desired.

5 Take the picture.



 Focus lock also works in the Basic Zone modes (except >). Just start from step 3 above.

When Autofocus Fails (Manual Focusing)

Autofocus can fail to achieve focus (the focus confirmation light <●> blinks) with certain subjects such as the following:

Difficult Subjects for Autofocusing

- Low-contrast subjects.
Example: Blue sky, flat surface with a solid color.
- Subjects in very low light.
- Extremely backlit or reflective subjects.
Example: Automobile with a strong reflection.
- Overlapping near and far objects.
Example: Animal behind bars in a cage.

In such cases, do one of the following:

- (1) Focus lock an object at the same distance as the subject and recompose.
- (2) Set the lens focus mode switch to <MF> and focus manually.

MF Manual Focusing

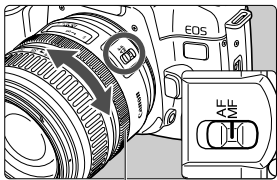

Focus ring

- 1 Set the lens focus mode switch to <MF>.**
- 2 Focus the subject.**
 - Turn the lens focusing ring until the subject looks sharp.

 If you hold down the shutter button halfway while focusing manually, the AF point achieving focus will flash in red and the focus confirmation light <●> will light.

Metering Modes★

The camera has three metering modes: Evaluative, partial, and center-weighted averaging metering. **The Basic Zone uses evaluative metering. In the Creative Zone, any of the three modes can be selected.**

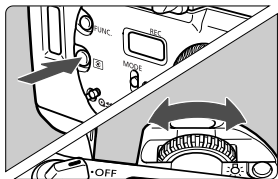

1 Press the  button. (ⓘ6)

2 Select the metering mode.

- Turn the  dial.



- To start shooting again, press the shutter button halfway or press the  button again.

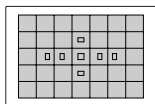

Evaluative metering

This is the camera's standard metering mode suited for most shooting including backlit conditions. Based on the subject's position in the viewfinder, brightness, background, front or back lighting conditions, etc., the camera always calculates the proper exposure for the subject.

- During manual focusing, evaluative metering is based on the center AF point.
- If the subject brightness and background light level are very different (strong backlight or spotlight), partial metering () is recommended instead.

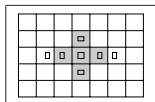

Partial metering

This is effective for backlit subjects. An area covering about 10% of the viewfinder screen at the center is used for metering. The partial metering area is shown on the left.

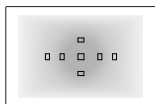

Center-weighted averaging metering

The metering is weighted at the center and then averaged for the entire scene.

C.Fn

Partial metering and FE lock can be linked to the active AF point. (See page 87 for C.Fn-08-1.)

4

User-Controlled Shooting

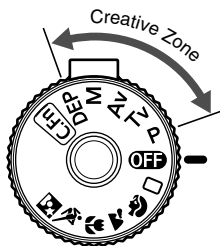

With Creative Zone modes, you can set the desired shutter speed or aperture value to obtain the exposure you want. You take control of the camera.

- The ★ symbol indicates that the respective feature can be used only in Creative Zone modes (P, Tv, Av, M, DEP).
- Press the shutter button halfway and release, and the exposure setting will be displayed for approximately 4 seconds on the LCD panel and viewfinder.
- The functions that can be set in Creative Zone modes are listed in the “Function Availability Table” (p.91).
- Before proceeding, turn the <☞> switch to <ON>.

P Program AE



Like the <□> (Full Auto) mode, this is a general-purpose mode to make picture-taking easy. It sets the shutter speed and aperture value automatically to suit the subject's brightness.

* <P> stands for Program.

* "AE" stands for auto exposure.



1 Turn the Mode Dial to <P>.

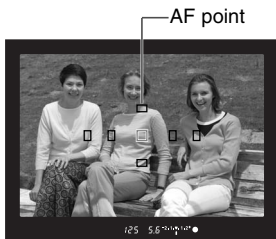

AF point

2 Focus the subject.

- Move the AF point over the subject and press the shutter button halfway.

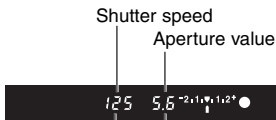

Shutter speed

Aperture value

3 Check the display.

- ▶ The shutter speed and aperture value are set automatically and displayed in the viewfinder and on the LCD panel.
- If the shutter speed and aperture value do not blink, a correct exposure will be obtained.



AF point mark

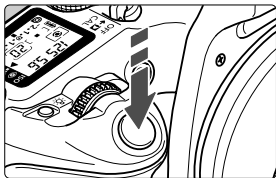

4 Take the picture.

- Compose the shot and press the shutter button fully.



- If the “30'” shutter speed and maximum aperture display blink, it means the subject is too dark. Use flash.
- If the “4000” shutter speed and minimum aperture display blink, it means the subject is too bright. Attach an ND filter (sold separately) to reduce the light entering the lens.



The Difference Between <P> and <□>

- The shutter speed and aperture value are set in the same way in both modes.
- The following features can be used in the <P> mode, but not in the <□> mode.

<ul style="list-style-type: none"> · Manual AF point selection · Metering mode selection · Film advance mode selection · Program shift · Exposure compensation · AEB · AE lock with the <✳> button · Depth-of-field preview · Multiple exposures 	<ul style="list-style-type: none"> · Custom Functions · Built-in flash manual firing · EX-series Speedlite compatibility <ul style="list-style-type: none"> - FE lock - High-speed sync (FP flash) - Flash ratio control · FEB · 2nd-curtain sync · Modeling flash
---	--

About Program Shift

- In the Program AE mode, you can freely change the shutter speed and aperture value combination (program) set by the camera while retaining the same exposure. This is called program shift.
- To shift the program, press the shutter button halfway and turn the <☀> dial until the desired shutter speed or aperture value is displayed.
- Program shift is canceled automatically after the picture is taken.
- Program shift cannot be set when the built-in flash is used.

Tv Shutter-Priority AE

In this mode, you set the shutter speed and the camera sets the aperture value automatically to suit the subject brightness. A fast shutter speed can freeze the motion of a fast-moving subject and a slow shutter speed can blur the subject to give the impression of motion.

* <Tv> stands for Time value which is the shutter speed.



Taken with a fast shutter speed.



Taken with a slow shutter speed.



1 Turn the Mode Dial to <Tv>.



2 Select the desired shutter speed.

- Turn the <☀> dial.
- The shutter speed can be set in half-stop increments.

3 Press the shutter button halfway to focus the subject.

- ▶ The aperture value is set automatically.

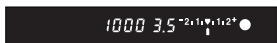

4 Check the viewfinder display and take the picture.

- A correct exposure will be obtained as long as the aperture value display is not blinking.



- If the maximum aperture value blinks, it indicates underexposure. Turn the dial to set a slower shutter speed until the blinking stops.
- If the minimum aperture value blinks, it indicates overexposure. Turn the dial to set a faster shutter speed until the blinking stops.



Shutter Speed Display

The shutter speeds from “4000” to “2” indicate the denominator of the fractional shutter speed. For example, “125” indicates 1/125 sec. Also, “0.7” indicates 0.7 sec, and “15” indicates 15 sec.

4000	3000	2000	1500	1000	750	500	350	250	180				
125	90	60	45	30	20	15	10	8	6	4	3	2	0.7
1"	1.5"	2"	3"	4"	6"	8"	10"	15"	20"	30"			

Av Aperture-Priority AE

In this mode, you set the desired aperture value and the camera sets the shutter speed automatically to suit the subject brightness.

The larger or brighter the aperture (lower f/number) the more blurred the background will become. This effect is ideal for portraits. The smaller or darker the aperture (higher f/number), the clearer the focus will be for both near and far objects (wider depth of field).

* <Av> stands for aperture value.



Taken with a large aperture.

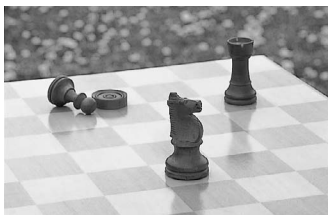

Taken with a small aperture.



1 Turn the Mode Dial to <Av>.

2 Select the desired aperture value.

- Turn the <  > dial.
- The aperture value can be set in half-stop increments.

3 Press the shutter button halfway to focus the subject.

- ▶ The shutter speed is set automatically.

4 Check the viewfinder display and take the picture.

- A correct exposure will be obtained as long as the shutter speed display does not blink.

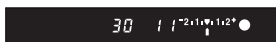



- If the slowest shutter speed blinks, it indicates underexposure. In such a case, turn the dial to set a larger aperture value (smaller f/number) until the shutter speed display stops blinking.
- If the fastest shutter speed blinks, it indicates overexposure. In such a case, turn the dial to set a smaller aperture value (larger f/number) until the shutter speed display stops blinking.



Aperture Value Display

The larger the f/number, the smaller the diaphragm will be. The aperture value display will differ depending on the lens. When no lens is attached to the camera, “00” will be display for the aperture value.

1.0	1.2	1.4	1.8	2.0	2.5	2.8	3.5	4.0	4.5	5.6	6.7	8.0	9.5
11	13	16	19	22	27	32	38	45	54	64	76	91	

Depth-of-field Preview★

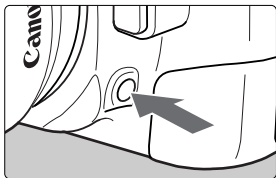

Press the depth-of-field preview button to stop down to the current aperture setting. The diaphragm in the lens will be set to the current aperture so you can check the depth of field (range of acceptable focus) through the viewfinder.



- This feature can be used in the Creative Zone.
- While you press the depth-of-field preview button, the exposure will also be locked (AE lock).

M Manual Exposure



In this mode, you set both the shutter speed and aperture as desired. To determine the exposure, refer to the exposure level indicator in the viewfinder or use a handheld exposure meter. This method is called manual exposure. In the <M> mode, the center-weighted averaging metering will be set automatically.

* <M> stands for Manual.



1 Turn the Mode Dial to <M>.

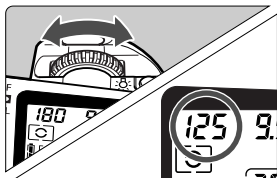

2 Select the desired shutter speed.

- Turn the <☀> dial.

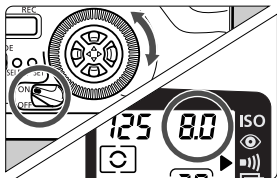

3 Select the desired aperture value.

- Turn the <☞> switch to <ON> and turn the <☀> dial.

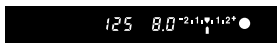

4 Press the shutter button halfway to focus the subject.

- ▶ The exposure setting will be displayed.
- The exposure level mark <█> indicates how close the exposure level is to the correct exposure.

5 Determine the exposure.

- Look at the exposure level indicator and set the shutter speed and aperture value as desired.

Standard exposure index

2, 1, ▾, 1, 2⁺



: This is the reference point for a standard exposure.

-2, 1, ▾, 1, 2⁺



: To set it to the standard exposure level, set a slower shutter speed or a larger aperture value (smaller f/number).

-2, 1, ▾, 1, 2⁺



: To set it to the standard exposure level, set a faster shutter speed or a smaller aperture value (larger f/number).

Exposure level mark

6 Take the picture.

 If the exposure level mark <▾> blinks at the <2⁺> or <-2> level, it indicates that the difference between the standard exposure exceeds +/-2 stops.

DEP Depth-of-field AE

The depth-of-field AE mode is for obtaining wide depth of field between a near and far subject. It is effective for group shots and landscapes. The optimum point of focus, aperture, and shutter speed are set automatically to obtain the desired depth of field. For DEP, you can specify the AF points manually or with Eye Control AF.

- The <DEP> mode cannot be used if the lens focus mode switch is set <MF>. Make sure it is set to <AF>.

* <DEP> stands for depth of field.

Depth-of-field AE with a Manually-Selected AF Point



- 1 Turn the Mode Dial to <DEP>.
▶ The AF mode will be set automatically to <ONE SHOT>.

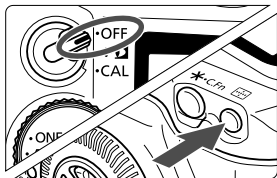

- 2 Turn the Eye Control switch to <OFF>.

- 3 Select the AF point.

- Press the <AF-ON> button and use the <↑> keys to select the AF point.
- If automatic AF point selection has been set, use the center AF point to focus.

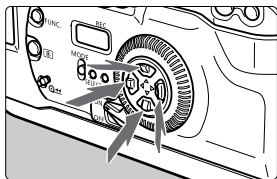

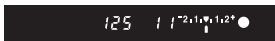

4 Focus the nearest subject.

- Aim the selected AF point on the nearest subject, then press the shutter button. (☺4)
- ▶ The focus confirmation light <●> will light, and “dEP 1” will be displayed.
- In steps 4 and 5, pressing the shutter button completely will not take the picture.

5 Focus farthest subject.

- Repeat step 4.
- ▶ “dEP 2” will be displayed.
- Steps 4 and 5 can also be done in reverse order.

6 Compose the picture and press the shutter button halfway. (☺4)

- ▶ The optimum point of focus, aperture, and shutter speed to obtain the desired depth of field are set automatically.
- When you let go of the shutter button, the display will change to “dEP”.
- The exposure setting is set when the picture is taken.

7 Take the picture.

- The desired depth of field will be obtained as long as the aperture value display does not blink.
- A correct exposure will be obtained as long as the shutter speed and aperture value displays do not blink.

DEP Depth-of-field AE

Depth-of-field AE with Eye Control (D Model only)

With Eye Control, you can easily set the desired depth of field without having to recompose so much.



1 Turn the Mode Dial to <DEP>.

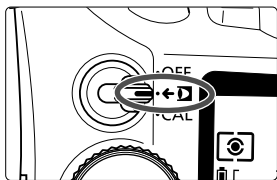

2 Set the Eye Control switch to <OFF>.

- Make sure the correct CAL No. has been set. (p.48)



3 Focus the nearest subject you want in focus.

- Look at the subject and press the shutter button. (4)
- ▶ The focus confirmation light <●> will light, and “dEP 1” will be displayed.
- In steps 3 and 4, pressing the shutter button completely will not take the picture.

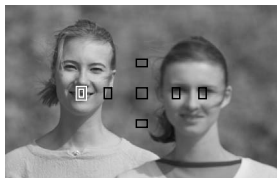

4 Focus the farthest subject you want in focus.

- Repeat step 3.
- ▶ “dEP 2” will be displayed.
- Steps 3 and 4 can also be done in reverse order.

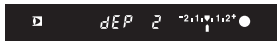

5 Press the shutter button halfway.

- While looking at the AF point where you want the exposure to be set, press the shutter button halfway.
- ▶ The optimum point of focus, aperture, and shutter speed to obtain the desired depth of field are set automatically.
- When you let go of the shutter button, the display will change to “dEP”.
- The exposure setting is set when the picture is taken.

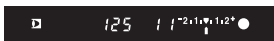

6 Take the picture.

- If the aperture value display does not blink, the desired depth of field will be obtained.
- A correct exposure will be obtained as long as the shutter speed and aperture displays do not blink.



- If the aperture display blinks, it means that the desired depth of field cannot be obtained. Move further away from the subject or use the wide-angle end if you are using a zoom lens. Then try it again.
- If the “30''” shutter speed and maximum aperture display blink, it means the subject is too dark. The <DEP> mode cannot be used.
- If the “4000” shutter speed and minimum aperture display blink, it means the subject is too bright. Attach an ND filter (sold separately) to reduce the light entering the lens.

DEP Depth-of-field AE



- If you are using a zoom lens, do not zoom before the picture is taken.
- If a slow shutter speed is set, use a tripod to prevent camera shake.
- The <DEP> mode cannot be used if the lens focus mode switch is set <MF>. The result will be the same as using the <P> mode.
- The <DEP> mode cannot be used if you use flash or remote control. The result will be the same as using the <P> mode with flash.
- If you are using the <DEP> mode with a lens that has a focus-limiting switch, set the switch to “minimum focusing distance - ∞.”



- To cancel <DEP> at any time, turn the Mode Dial to any setting except <DEP>.
- To check the depth of field while using depth-of-field AE, set DEP points 1 and 2 and press the shutter button halfway. Then press the depth-of-field preview button.
- To further increase the depth of field, use a wide-angle lens.
- Setting DEP points 1 and 2 at the same point on the subject will make the depth of field shallow. The foreground and background will then be blurred, making the subject stand out. Using a telephoto lens enhances this effect.

Exposure Compensation★

Exposure compensation is used to alter the camera's standard exposure setting. You can make the picture look lighter (increased exposure) or darker (decreased exposure). The exposure compensation amount can be set up to ± 2 stops in half-stop increments.

1 Turn the Mode Dial to a Creative Zone mode except <M>.

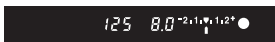

2 Check the exposure setting.

- Press the shutter button halfway and check the display.

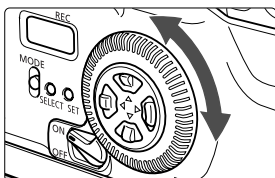

3 Set the exposure compensation amount.

- Turn the <ON> switch to <ON> and turn the <DIAL> dial.
- To cancel the exposure compensation, set the exposure compensation amount to <0>.

Increased exposure

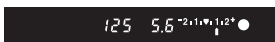

Decreased exposure

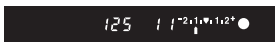

Standard exposure index

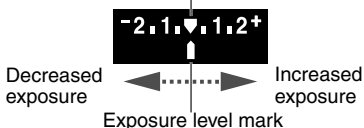

4 Take the picture.

- The exposure compensation amount set is retained even after the Mode Dial is set to <OFF>.
- Assuming that a shutter speed of 1/125 sec. and an aperture value of f/8.0 will give a correct exposure, setting the exposure compensation amount to plus or minus 1 stop will change the shutter speed or aperture value as follows:

	-1 stop	←	0	→	+1 stop
Shutter speed	250	←	125	→	60
Aperture value	11	←	8.0	→	5.6

Auto Exposure Bracketing (AEB)★

With AEB, the camera automatically changes the exposure within a set range (up to ± 2 stops in $1/2$ -stop increments) for three successive frames.



Standard exposure (0)



Decreased exposure ($-1/2$ stop)



Increased exposure ($+1/2$ stop)

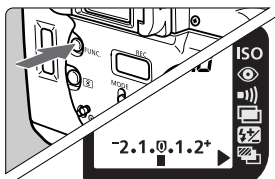

1 Move the arrow to the icon.

- Look at the LCD panel and press the **<FUNC.>** button. (06)

AEB amount

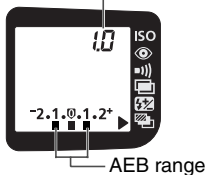

AEB range

2 Set the desired AEB amount.

- Turn the  dial.
- Press the shutter button halfway to return to normal camera operation.

3 Take the picture.

- ▶ The three bracketed shots will be exposed in the following sequence: standard exposure, decreased exposure, and increased exposure.
- ▶ As shown on the left, the respective bracketing amount will be displayed as each bracketed shot is taken.
- ▶ The picture will be taken in the current film advance mode.

standard exposure

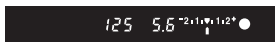

decreased exposure

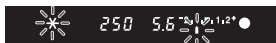

increased exposure

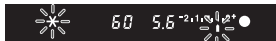

Canceling AEB



- After the three bracketed shots are taken, the AEB setting will not be canceled automatically. To cancel AEB, follow steps **1** and **2** to set the AEB amount to “0.0”.
- AEB will also be canceled automatically if the flash is ready to fire.

AEB cannot be used with flash or bulb exposures.

- During AEB shooting, the <▶> arrow will appear next to the <AEB icon> and the AEB level <■> will be displayed. In the viewfinder, the <✱> icon will blink.
- In the <□> film advance mode, the camera stops shooting automatically after taking the three AEB shots. In the <□> (single frame) mode, press the shutter button completely three times to take the three AEB shots.
 - If you use the self-timer or remote control, the three AEB shots will be taken continuously automatically.
 - If C.Fn-05-1 is set (mirror lockup), single-frame film advance will take effect during AEB shooting even if the continuous film advance mode has been set.
 - AEB can also be set in combination with exposure compensation. If you set the exposure compensation amount beyond the displayable range, the indicator will look as shown below. However, the exposure compensation amount will still take effect.

In the <P> <Tv> <Av> <DEP> modes:

: ±1 stop AEB.

: ±1 stop AEB with –1-stop exposure compensation.

: ±1 stop AEB with –1.5-stop exposure compensation.

: ±1 stop AEB with –2-stop exposure compensation.

In the <M> mode:

: ±1 stop AEB with –2-stop exposure compensation.

: ±1 stop AEB with over –2-stop exposure compensation.

✳ AE Lock ✳

AE lock enables you to lock the exposure at a different spot from the point of focus. After locking the exposure, you can recompose the shot while maintaining the desired exposure level. This feature is useful for backlit and spotlighted subjects.

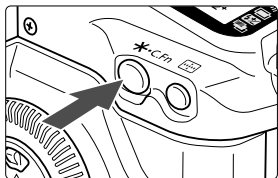

1 Focus the subject.

- Press the shutter button halfway to focus.
- ▶ The exposure setting will be displayed.

2 Press the <✳> button. (ⓘ4)

- ▶ The <✳> icon will light in the viewfinder to indicate that the exposure setting has been locked (AE lock).
- Each time you press the <✳> button, it locks the current exposure setting.



AE lock indicator

3 Compose the shot and take the picture.

- If you want to maintain the AE lock while taking more pictures, hold down the <✳> button and press the shutter button to take another picture.



- In the One-Shot AF and AI Focus AF modes (except AI SERVO AF), AE lock will take effect while you press the shutter button halfway to focus.
- AE lock works differently depending on the selected AF point and metering mode. For details, see “AE Lock Effects” (p.92).

C.Fn

C.Fn-04-1 enables you to apply AE lock by pressing the shutter button halfway and focus by pressing the <✳> button. (p.85)

Bulb Exposures★

When bulb is set, the shutter is open while you keep pressing the shutter button fully. Bulb exposures are useful when long exposures are required for night scenes, fireworks, astronomical photography, etc.



1 Turn the Mode Dial to <M>.

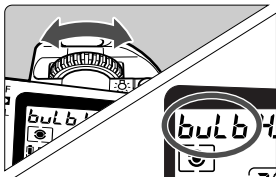

2 Set the shutter speed to "bulb".

- Look at the LCD panel and turn the <☀> dial to select "bulb".
- "bulb" follows "30".

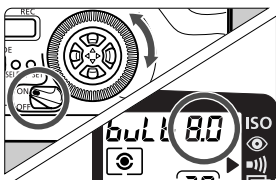

3 Select the desired aperture value.

- Turn the <☞> switch to <ON> and turn the <☉> dial.

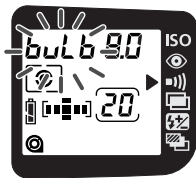

4 Start the bulb exposure.

- ▶ During the bulb exposure, "bulb" blinks on the LCD panel.
- The bulb exposure continues as long as you hold down the shutter button.

- Remote Switch RS-60E3 (sold separately) is convenient for bulb exposures.
- Bulb exposures are also possible with the Remote Controller RC-1/RC-5 (sold separately). When you press the transmit button, the exposure will start. To end the exposure, press the button again.
- With a new set of batteries, the maximum bulb exposure time (at 20°C) will be about 10 hours.

Multiple Exposures★

The film is not advanced after each shot, so you can expose multiple shots on the same frame. Shoot up to nine shots on a single frame.

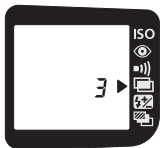
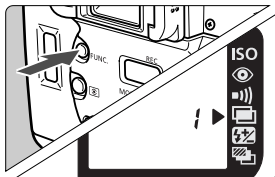

1 Move the <▶> arrow to the <Multiple Exposures icon> icon.

- Look at the LCD panel and press the <FUNC.> button. (ⓘ6)
- ▶ “1” will be displayed.

2 Set the desired number of multiple exposures.

- Turn the <Exposure Compensation dial> dial.
- Press the shutter button halfway to return to normal camera operation.

3 Take the picture.

- ▶ After you take all the multiple exposures, the film advances to the next frame automatically and the multiple-exposure setting is canceled.

 If you shoot multiple exposures on the first few or last few frames of a roll, the multiple exposures might not be precisely aligned due to the film curling.

-  During multiple-exposure shooting, the <▶> arrow next to the <Multiple Exposures icon> icon on the LCD panel will blink.
- To cancel multiple exposures before shooting, set the number of multiple exposures to “1”.
- To cancel multiple exposures after shooting, follow steps 1 and 2 to set the number of multiple exposures to blank.
- Since the same frame is exposed multiple times, exposure compensation should be set to a negative value for each shot.

General Guide for Exposure Compensation

These are only suggested exposure compensation amounts. The optimum amount depends on the scene. Experiment to find the optimum compensation amount.

Multiple Exposures	2 exposures	3 exposures	4 exposures
Exposure Compensation Amount	-1.0 stop	-1.5 stop	-2.0 stop

■) Silencing the Beeper

The beeper can be silenced in all of the picture-taking modes.

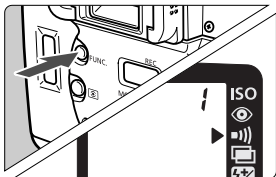

1 Move the <■) > arrow to the <■) > icon.

- Look at the LCD panel and press the <FUNC.> button. (ⓘ6)

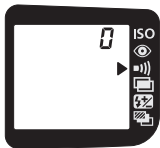

2 Set the setting to “0”.

- Turn the <☀> dial.
- To enable the beeper to sound, set to “1”.
- Press the shutter button halfway to return to normal camera operation.

☀ LCD Panel Illumination

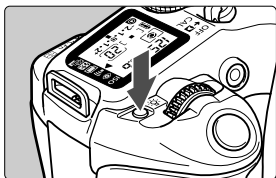

LCD panel illumination is provided. Press the <☀> button to illuminate the LCD panel for about 5 sec. The illumination can be turned off by pressing the button again. Turn on the illumination when it is too dark to see LCD panel. The illumination turns off automatically after the picture is taken.

 If you use any button or dial for shooting while the LCD panel is illuminated, the illumination time will be extended.

Mirror Lockup★

Mirror lockup is enabled with C.Fn-05-1. This prevents mirror-caused vibrations which may blur the image during close-ups or when a telephoto lens is used. To set this Custom Function, see “Setting a Custom Function” on page 84. When mirror lockup is set, the camera operates as follows.

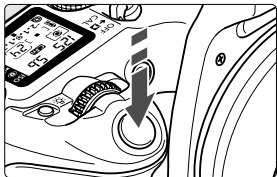

1 Press the shutter button fully.

- ▶ The mirror will lock up.
- ▶ After 30 seconds, it will go back down automatically.

2 Press the shutter button fully again.

- ▶ The picture will be taken and the mirror will go back down.
- To take another shot with mirror lockup, start from step 1 again.

- If you are shooting a very bright scene such as the beach or ski slope with mirror lockup, take the picture promptly after the mirror goes up.
- During mirror lockup, do not point the lens toward the sun. Doing so may damage the shutter curtains due to the sun's heat.
- If you use mirror lockup with the self-timer for a bulb exposure, keep pressing the shutter button completely (10-sec. self-timer + bulb exposure). If you let go of the shutter button during the self-timer, there will be a shutter-release sound. It is not the shutter release.

- For mirror lockup, using the Remote Switch RS-60E3 or Remote Controller RC-1/RC-5 (both sold separately) is recommended.
- During mirror lockup, the film advance mode will be Single even if it is set to .
- If mirror lockup is used with the self-timer, pressing the shutter button fully will lock up the mirror first and the picture will be taken 10 sec. later.

Wireless Remote Control

With Remote Controller RC-1 (sold separately), wireless operation is possible up to 5 m/16.4 ft away from the front of the camera.



1 Turn the film advance mode lever to .

- ▶ The icon appears on the LCD panel.

2 Take the picture.

- Point the signal transmitter toward the camera's remote control sensor and press the signal button.
- ▶ The remote control lamp will light, and the picture will be taken.
- For details on using the remote control, see the RC-1's instructions.

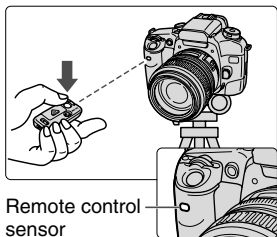

Remote control sensor

⚠ Certain types of fluorescent light may cause camera misoperation. During wireless remote control, try to keep the camera away from fluorescent light.

- You can also use Remote Controller RC-5 (sold separately).
- If you set the film advance mode lever to and do nothing for four minutes, the wireless remote control mode will be canceled automatically to save battery power.

Using the Remote Switch

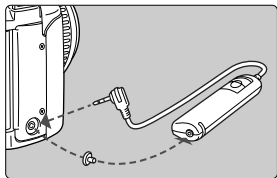

Connect the Remote Switch RS-60E3's (sold separately) plug to the camera's remote control terminal. To take a picture, press the Remote Switch's shutter-release button.

5

Flash Photography

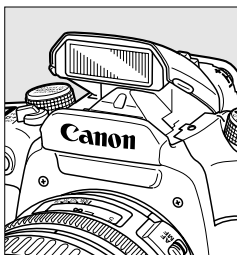

With the built-in flash or EOS-dedicated Speedlite, you can easily take flash pictures in the same way as normal AE shooting. In the Basic Zone modes (except), the built-in flash is fully automatic. In Creative Zone modes, it can be used at any time.

Using the Built-in Flash

In a Basic Zone Mode

In low-light or backlit conditions, **the built-in flash will pop up and fire automatically** (except in <📷> <📷> modes).

In a Creative Zone Mode

Just pop-up the built-in flash to fire the flash regardless of the ambient light level.

- P** : Use this mode for automatic flash photography. The flash sync speed (within 1/60 sec. - 1/125 sec) and aperture value will be set automatically as with the <☐> (Full Auto) mode.
- Tv** : Use this mode if you want to set the flash sync speed manually (within 30 sec. - 1/125 sec.). The camera will set the flash aperture value automatically to obtain a correct flash exposure.
- Av** : Use this mode if you want to set the flash aperture value. The camera will set the flash sync speed (within 30 sec. - 1/125 sec.) automatically to obtain the best exposure for the aperture you set. For portraits with a night scene or dark background, a slow sync speed will be set to obtain a proper exposure for both the subject and background. The flash illuminates the subject, while the background is properly exposed with a slow shutter speed.
- Because automatic slow-sync shooting uses a slow shutter speed, always use a tripod.
- M** : Enables you to manually set the shutter speed (30 sec. - 1/125 sec. or bulb) and aperture. The subject is properly exposed with the flash and the background is exposed with the flash sync speed and aperture value you have set.
- DEP** : This mode gives the same flash result as the <P> mode.

Flash Distance Range (With EF28-105mm f/3.5-4.5)

[m/ft]

ISO	28mm		90mm	
	Negative Film	Slide Film	Negative Film	Slide Film
100	1 - 5.2 / 3.3 - 17.2	1 - 3.7 / 3.3 - 12.1	1 - 4.0 / 3.3 - 13.4	1 - 2.8 / 3.3 - 9.4
200	1 - 7.4 / 3.3 - 24.3	1 - 5.2 / 3.3 - 17.2	1 - 5.7 / 3.3 - 18.9	1 - 4.0 / 3.3 - 13.4
400	1 - 10.5 / 3.3 - 34.4	1.2 - 7.4 / 3.9 - 24.3	1 - 8.1 / 3.3 - 26.8	1 - 5.7 / 3.3 - 18.9

- Use the built-in flash at least 1 meter (3.3 ft) away from the subject. Closer distances may result in the flash partially obstructed by the lens barrel.
- When using the built-in flash, detach any hood attached to the lens. A lens hood will partially obstruct the flash coverage.
- When a super telephoto lens or a fast, large-aperture lens is attached, the built-in flash coverage might be obstructed. Using an EOS-dedicated Speedlite is recommended.
- The built-in flash's flash coverage is suited for a 28mm lens. If you use a shorter wide-angle lens, the flash picture may look dark along the periphery.

- To retract the built-in flash, push it down.
- In **<Tv>** or **<M>** mode, even if you set the shutter speed faster than 1/125 sec. 1/125 sec. will be set automatically.
- If the camera finds it difficult to focus, the AF-assist beam will fire automatically (except **<▲>** **<👁>**).

- C.Fn**
 - C.Fn-07-3 disables the built-in flash from firing. (p.86)
 - C.Fn-06-1 enables 2nd-curtain sync with the built-in flash. (p.86)
 - With C.Fn-09-1, the flash sync speed will be fixed at 1/125 sec. in the **<Av>** mode. (p.87)

Using the Built-in Flash

Flash Exposure Compensation★

Flash exposure compensation can be set in the same way as with exposure compensation. It can be set up to ± 2 stops in 1/2-stop increments.

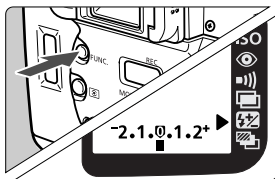

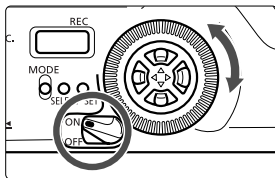

1 Move the \blacktriangle arrow to the icon on the LCD panel.

- Press the <FUNC.> button to move the arrow. (06)



2 Set the flash exposure compensation amount.

- Turn the  switch to <ON> and turn the  dial.
- To cancel flash exposure compensation, set the amount back to <0>.
- Press the shutter button halfway to return to normal camera operation.

Increased flash exposure

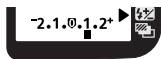

Decreased flash exposure

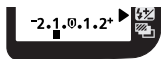

Re flash exposure index

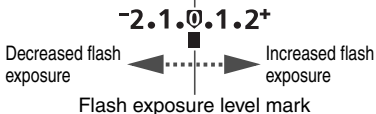

3 Take the picture.

- The flash exposure compensation amount is retained even after the Mode Dial is set to <OFF>.
- You can also set the compensation amount with the Main Dial.
- Even with an EOS-dedicated Speedlite attached, you can still set the flash exposure compensation with the camera as explained above.

Using an EOS-dedicated Speedlite

The camera is compatible with the EX/EZ/E/EG/ML/TL-series EOS-dedicated Speedlites.

For details on operating the Speedlite, refer to the Speedlite's instruction booklet.

Using an EX-series Speedlite

With E-TTL II autoflash (AF point-linked, evaluative flash metering with preflash), you can easily take natural-looking flash pictures centering on the subject in the same way as normal AE shooting.



Using an EZ/E/EG/ML/TL-series Speedlite

With A-TTL/TTL autoflash (AF point-linked, off-the-film flash metering), you can easily take flash pictures in the same way as normal AE shooting.

About E-TTL II Autoflash

E-TTL II is a new autoflash exposure system incorporating improved flash exposure control and lens focusing distance information, making it more precise than the previous E-TTL (evaluative flash metering with preflash) system.

The camera can execute E-TTL II autoflash with any EX-series Speedlite.

- Before attaching an external Speedlite, retract the built-in flash.
- If you use a flash unit (with multiple contacts) dedicated to another camera brand or a high-voltage flash, the camera may not work properly or malfunction may result.
- If focus is difficult to achieve, the EOS-dedicated Speedlite (one with a built-in AF-assist light) will automatically emit the AF-assist light (except in modes).
- With regard to EOS-dedicated Speedlites, this is a Type A camera (compatible with E-TTL II autoflash).

Using an EOS-dedicated Speedlite

C.Fn

- C.Fn-07-3 can disable the EOS-dedicated Speedlite from firing a flash. (p.86)
- C.Fn-06-1 can set second-curtain flash synchronization for an EOS-dedicated Speedlite. (p.86)
- With C.Fn-09-1, the flash sync speed will be fixed at 1/125 sec. in the <Av> mode. (p.87)

6

Custom Functions (C.Fn)

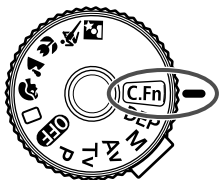

Custom Functions enable you to customize various camera features to suit your picture-taking preferences.

In the previous text, the < **C.Fn** > symbol was used to point out relevant Custom Functions. In this chapter, all the Custom Functions are described in detail.

- **Custom Function settings are applied in the Creative Zone modes. They are not applied in the Basic Zone modes.**

C.Fn Setting a Custom Function



1 Turn the Mode Dial to < C.Fn >.

- ▶ The < C.Fn > icon and Custom Function No. are displayed on the LCD panel.

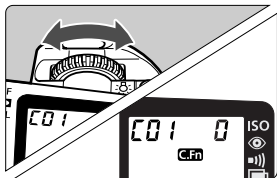

2 Select the Custom Function No.

- Turn the < > dial to select the Custom Function No.

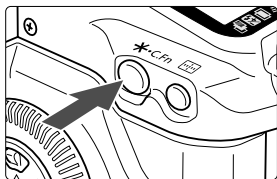

3 Set the Custom Function setting.

- Press the < *C.Fn > button. The Custom Function setting changes each time you press the button.
- The “0” setting is the default.
- Repeat steps 2 and 3 above to set any other Custom Functions.

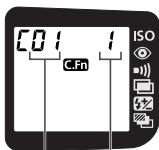

4 Finalize the setting.

- Turn the Mode Dial to a shooting mode.
 - ▶ The < C.Fn > icon remains displayed on the LCD panel and the Custom Function setting is set.

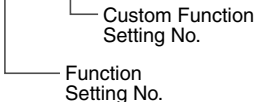

“C.Fn” stands for Custom Function.

Custom Function Settings

C.Fn-01 Film rewind speed

Increase the film rewind speed.

0 : Normal (silent) rewind

1 : High-speed rewind

C.Fn-02 Film leader position after film rewind

Prevent the film leader from being rewound in the film cartridge after film rewind.

0 : Rewinds film leader into the cartridge

1 : Leaves film leader outside the cartridge

C.Fn-03 DX-coded film speed setting method

Prevent the camera from automatically setting the ISO film speed when the film is loaded.

0 : Enabled

1 : Disabled

C.Fn-04 Shutter button and <✳> functions

0 : AF activation with shutter button pressed halfway, and AE lock with the <✳> button.

1 : AF activation with the <✳> button, and AE lock with shutter button pressed halfway.

Makes focusing and AE lock separate operations.

2 : AF activation with shutter button pressed halfway, and suspend AF operation with the <✳> button.

During AI SERVO AF, if an obstruction comes in front of the subject, you can press the <✳> button to stop the AF operation momentarily. The exposure is determined when the shot is taken.

Custom Function Settings

C.Fn-05 Mirror lockup

0 : Disabled (Normal operation)

1 : Enabled

Effective for close-up and telephoto shots to prevent camera shake caused by the mirror's reflex action. See page 75 to use this feature.

C.Fn-06 Shutter curtain sync with built-in flash/EOS-dedicated Speedlite

0 : 1st-curtain sync

1 : 2nd-curtain sync

With second-curtain sync and a slow shutter speed, you can create a light trail following a moving subject. The flash fires right before the shutter closes. Second-curtain sync can be set even with EOS-dedicated Speedlites which cannot switch the shutter curtain synchronization. The Speedlite with a shutter curtain synchronization setting will override the camera's setting.

C.Fn-07 AF-assist beam emission / Main flash firing

The AF-assist beam from the camera and the EOS-dedicated Speedlite can be enabled/disabled, and the flash from the camera and EOS-dedicated Speedlite can be enabled/disabled.

0 : Enable AF-assist and flash

1 : Disable AF-assist and enable flash

2 : Enable AF-assist only with EOS Speedlite and enable flash

3 : Enable AF-assist and disable flash

C.Fn-08 Partial metering linkage with AF point/FE lock

Partial metering and FE lock can be linked to the selected AF point. Effective for composing the shot.

0 : Disabled (Partial metering/FE lock linked to center AF point)

1 : Enabled

C.Fn-09 Flash sync speed in Av mode

0 : Auto

1 : 1/125 sec. (fixed)

When you use flash in the aperture-priority mode (Av), the flash sync speed will be fixed at 1/125 sec. This prevents the camera from setting a slow sync speed in low-light conditions.

C.Fn-10 Superimposed display for focus confirmation

0 : On



1 : Off

Disables the AF point from flashing in red when it achieves focus. When the AF point is selected, it will still flash in red.





C.Fn-11 AF point selection method

0 :  button + 

1 : Select AF point manually with  or select automatically with 

While the metering is active ()⁴, you can manually select the AF point with the  button. Convenient if you have to change the AF point often or if you want to change the AF point in the AI SERVO AF mode.

2 :  button +  < 

After you press the  button, turn the  or  dial to select the AF point. Turn the  dial to select a horizontal AF point or turn the  dial to select a vertical AF point.

C.Fn-12 Switch to center AF point with the button

0 : Disabled

1 : Enabled

Press the  button to immediately switch to the center AF point. Convenient if you often use the center AF point.

C.Fn-13 Lens AF stop button function

0 : AF stop

1 : AF start

AF operates only while the AF stop button is pressed. While you press the button, AF operation with the camera is disabled.

2 : AE lock while metering

When you press the button while metering timer is still active, AE lock takes effect. Convenient when you want to focus and meter separately.

3 : AF point selection method switching (between automatic and manual).

In the manual AF point selection mode, holding down the button switches to automatic AF point selection. Holding down the button switches from manual AF point selection to automatic AF point selection immediately. Convenient when you are no longer able to focus track a moving subject with a manually-selected AF point in the AI Servo AF mode.

In the automatic AF point selection mode, holding down the button selects the center AF point.

4 : AF mode switching (between One-Shot AF and AI Servo AF)

In the One-Shot AF mode, holding down the button switches to AI Servo AF mode. In the AI Servo AF mode, holding down the button switches to One-Shot AF mode. Convenient when you need to keep switching between One-Shot AF and AI Servo AF for a subject that keeps moving and stopping.

5 : IS start

With the lens' IS switch already ON, the Image Stabilizer operates only while you hold down the AF stop button.



The AF stop button is provided only on super telephoto lenses.

Basic Photography Terms

AE

Abbreviation for auto exposure. It is an automatic metering and exposure system that sets the optimum exposure (shutter speed and/or aperture value) based on the reading by the built-in exposure meter.

Exposure

Exposure occurs when the film is exposed to light. Correct exposure is obtained when the film is exposed to a proper amount of light in accordance with the film's sensitivity to light. The correct exposure is adjusted with the camera's shutter speed and aperture.

Shutter speed

The shutter speed is the length of time the camera's shutter opens to expose the film to the light coming through the lens. The camera displays the shutter speed from "4000" (1/4000 sec.) to "30'" (30 sec.) and "bulb".

Aperture value

The aperture setting (f-number) indicates the size of the aperture opening in the lens. It is used to adjust the amount of light striking the film. The camera can display the aperture setting from "f1" to "f16". The actual aperture range displayed depends on the lens.

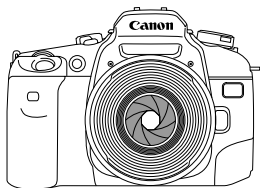

ISO film speed

The ISO film speed indicates the film's sensitivity to light. The higher the film speed, the more sensitive the film is. Therefore, ISO 400 and higher-speed films are suited for low-light conditions. The ISO film speed is set in accordance with standards set by the International Standardization Organization (ISO). The camera can display the ISO film speed from "5" to "6400".

Basic Photography Terms

Depth of field

This is the range where acceptable focus can be achieved in front of and behind the point of focus. The smaller the aperture value (the higher the f/number), the deeper the depth of field. And the larger the aperture value (the lower the f/number), the shallower the depth of field.

The depth of field is affected as described below:

(1) A smaller aperture value (a higher f/number) increases the depth of field.

For example, stopping down to $f/8$ obtains a deeper depth of field than $f/4.5$.

(2) A lens with a shorter focal length increases the depth of field.

A wide-angle lens obtains a deeper depth of field than a telephoto lens.

(3) A longer distance between the camera and subject increases the depth of field.

(4) The depth of field behind the point of optimum focus (2) is longer than the depth of field in front of the point of optimum focus (1).

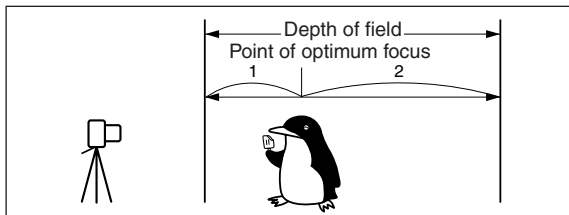

Aperture set to $f/2$.



Aperture set to $f/22$.

Feature Availability Table

● : Set automatically. ○ : User-selectable/settable. ※ (p.48)

Mode Dial mode								P	Tv	Av	M	DEP	
AF	One-Shot		●	●	●		●	○	○	○	○	●	
	AI Servo					●		○	○	○	○		
	AI Focus	●						○	○	○	○		
	AF Point Selection	Auto	●	●	●	●	●	●	○	○	○	○	○
		Manual							○	○	○	○	○
		Eye Control*	※	○	○	○	○	○	○	○	○	○	○
	AF-Assist beam	●	●		●		●	○	○	○	○	○	
Metering Mode	Evaluative	●	●	●	●	●	●	○	○	○	○	○	
	Partial							○	○	○	○	○	
	Center-weighted avg.							○	○	○	○	○	
Film Advance	Single	●		●	●		●	○	○	○	○	○	
	Continuous		●			●		○	○	○	○	○	
	Self-timer	○	○	○	○	○	○	○	○	○	○	○	
Built-in Flash	Auto Firing	●	●		●		●						
	Manual Firing							○	○	○	○	○	
	Flash off			●		●		○	○	○	○	○	
Exposure Compensation								○	○	○		○	
AE Lock								○	○	○		○	
Functions	ISO Speed							○	○	○	○	○	
	Red-eye Reduction	○	○		○		○	○	○	○	○	○	
	Beeper	○	○	○	○	○	○	○	○	○	○	○	
	Multiple Exposures							○	○	○	○	○	
	Flash Exposure Compensation							○	○	○	○	○	
	AEB							○	○	○	○	○	
Midroll Rewind		○	○	○	○	○	○	○	○	○	○	○	
Custom Functions								○	○	○	○	○	

* Model only

AE Lock Effects

AF Point Selection Method		Manual AF Point Selection / Eye Control	Automatic AF Point Selection
<input checked="" type="checkbox"/> Evaluative		AE lock is set at the selected AF point.	AE lock is set at the AF point which achieved focus.
<input checked="" type="checkbox"/> Partial	C.Fn-08-0	AE lock is set at the center AF point.	AE lock is set at the center AF point.
	C.Fn-08-1	AE lock is set at the selected AF point.*	
<input type="checkbox"/> Center-weighted averaging		AE lock is set at the center AF point.	

* If you use Eye Control AF and press the <★> button before you press the shutter button halfway, AE lock will be applied to the center AF point.

AF Mode and Film Advance Mode Combination

Film Advance Mode	One-Shot AF	AI Servo AF	AI Focus AF
<input type="checkbox"/> (Single frame)	The picture cannot be taken until focus is achieved. When focus is achieved, it also locks at the same time. The evaluative metering's exposure setting is also locked. (The exposure setting is retained until the picture is taken.)	The subject is focus-tracked for continuous autofocus. The exposure is set when the picture is taken.	Automatically switches between One Shot AF and AI Servo AF according to the subject status.
<input checked="" type="checkbox"/> (Continuous)	The same conditions above apply during continuous shooting. (approx. 4 frames per sec.)	The same conditions above apply during continuous shooting. (approx. 3.5 frames per sec.)	

Program Line

The program line below applies when the camera is used in the <P> Program AE mode with an EF 28-105mm f/3.5-4.5 lens.

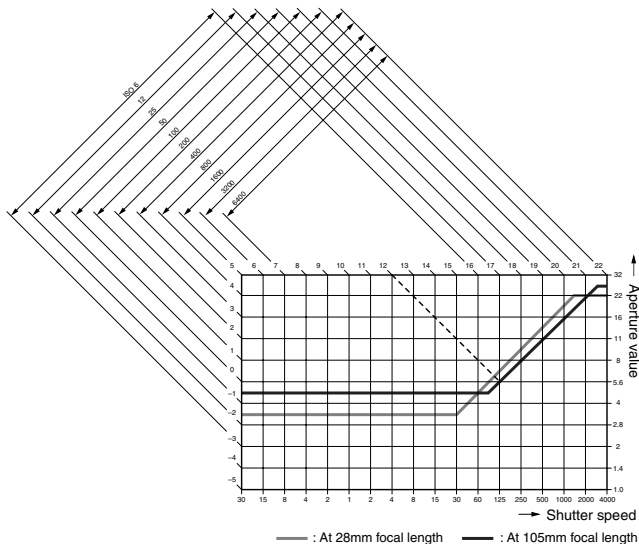

Program Line Description

The bottom horizontal axis represents the shutter speed and the right vertical axis represents the aperture value. On the left edge and top edge of the graph, the Exposure Value (EV) is indicated for the respective shutter speed and aperture value combination set by the Program AE mode and denoted by the program line.

Example: When the 105mm focal length is used and the subject brightness is EV 12, the point where the diagonal line from EV 12 (on the top edge of the graph) intersects the program line indicates the corresponding shutter speed (1/125 sec.) and aperture value (f/5.6) which the program sets automatically.

The arrowhead lines above the graph indicate the metering range for the respective film speed.

Troubleshooting Guide

If there is a problem, first refer to this Troubleshooting Guide.

Nothing is displayed on the LCD panel.

The batteries are exhausted. / The batteries have been installed incorrectly.

- ▶ Replace the batteries with new ones. / Install the batteries correctly. (p.18)

The picture looks blurred.

The lens focus mode switch is set to <MF>.

- ▶ Set the lens focus mode switch to <AF>. (p.20)

There was camera shake when the picture was taken.

- ▶ Hold the camera steady or use a faster shutter speed. (p.21)

The shutter does not work.

On the LCD panel, the frame count is not displayed and the <@> icon blinks.

- ▶ Take out the film and load it correctly. (p.22)

The focus confirmation light <●> in the viewfinder blinks and focus cannot be achieved.

- ▶ Select another AF point. (p.41)
If focus still cannot be achieved, focus manually. (p.51)

The <⏏> icon blinks on the LCD panel.

The battery level is very low.

- ▶ Replace the batteries with new ones. (p.18)

A misoperation has occurred.

- ▶ Press the shutter button halfway. (p.21) / Remove the batteries and reload it. (p.18) If the blinking <⏏> icon does not turn off, consult your nearest Canon dealer.

Major Specifications

• Type

Type.....	35 mm AF/AE SLR camera with built-in flash
Recording media	35 mm film
Image size	24 x 36 mm
Compatible lenses.....	Canon EF lenses (except EF-S lenses)
Lens mount	Canon EF mount (electronic control)

• Viewfinder

Type.....	Eye-level pentaprism
Coverage	90% vertical and 92% horizontal coverage
Magnification	0.7x (-1 diopter with 50mm lens at infinity)
Eye point	19.5 mm
Dioptic adjustment range ...	-2.5 - +0.5 diopter
Focusing screen	Fixed, all-matte screen
Mirror	Quick-return half mirror (Transmission:reflection ratio of 40:60, no mirror cut-off with EF 600mm f/4 or shorter lens)
Viewfinder information.....	AF (AF points, focus confirmation light, Eye Control*); Exposure (shutter speed, aperture value, exposure level, AE lock); Flash (flash ready, red-eye reduction, high-speed sync, FE lock, Flash Exposure Compensation)
Depth-of-field preview	Depth-of-field preview button

• Autofocus

Type.....	TTL-CT-SIR with a CMOS sensor (TTL secondary image-registration, phase detection)
AF points	7
AF working range	EV 1 - 18 (at 20°C, ISO 100)
Focusing modes	One-Shot AF, AI Servo AF, AI Focus AF, Manual focusing (MF)
AF point selection.....	Automatic selection, manual selection, manual selection with Eye Control (Eye Control AF)*
Selected AF point display ...	Superimposed in viewfinder and displayed on LCD panel.
AF-assist beam	Built-in flash fires intermittent burst automatically. Effective range: Approx. 4.5 meters at center, Approx. 4 meters at periphery.

• Eye Control*

Type.....	Eye position detected by IREDS.
Calibration	Up to five calibration settings can be stored (Intelligent feature provided).

Major Specifications

• Exposure control

Exposure metering modes	...TTL full aperture metering with 35-zone SPC <ul style="list-style-type: none">• Evaluative metering (linkable to any AF point)• Partial metering (approx. 10% of viewfinder at center)• Center-weighted average metering
Metering rangeEV 1 - 20 (normal temperature, 50mm f/1.4, ISO 100)
Exposure controlProgram AE (Full Auto, Portrait, Landscape, Close-up, Sports, Night Portrait, Program), shutter-priority AE, aperture-priority AE, depth-of-field AE, manual exposure, E-TTL II/A-TTL/TTL autoflash
Film speedsISO 6 - 6400 (Set automatically for DX-coded film within ISO 25 - 5000)
Exposure compensationManual exposure compensation: ± 2 stops in 1/2-stop increments (can be used with AEB) Auto Exposure Bracketing (AEB): ± 2 stops in 1/2-stop increments
AE lockAuto AE lock: In One-Shot AF mode, AE lock applied when focus achieved. Manual AE lock: AE lock applied with AE lock button.
Multiple exposuresMax. 9 exposures

• Shutter

TypeElectronically controlled focal-plane shutter
Shutter speeds1/4000 - 30 sec. in 1/2-stop increments, bulb, X sync at 1/125 sec.
Shutter releaseSoft touch electromagnetic release
Self-timerShoot after 10 sec. delay
Remote controlRemote Switch RS-60E3, Remote Controller RC-1/RC-5

• Built-in Flash

TypeRetractable, auto pop-up flash
Flash metering systemAF point-linked, 3-zone TTL autoflash
Guide No.13 (ISO 100, meters), 43 (ISO 100, ft.)
Recycling timeApprox. 2 sec.
Flash-ready indicatorFlash-ready icon lights in viewfinder
Flash coverage28mm lens angle covered
Firing preconditionsIn Basic Zones (except Landscape and Sports): Auto pop-up and firing in low light and backlit conditions in daylight.
Red-eye ReductionLamp
Flash exposure compensation ± 2 stops in 1/2-stop increments.

- **External Speedlite**E-TTL II/A-TTL/TTL autoflash with EOS-dedicated Speedlites

- **Film transport**

- Film loadingAutomatic advance to frame 1.
- Film advance modesSingle-frame / continuous shooting / Self-timer/Remote control
- Continuous shooting speeds...One Shot AF: Max. 4 fps
AI Servo AF: Max. 3.5 fps
- Frame counterCounts up
- Film rewindAutomatic. Mid-roll rewind
- Film rewind timeSilent: Approx. 13 sec., High-speed: Approx. 5 sec. (24-ex. film)

- **Date imprinting (DATE Mode only)**

- Automatic datingUp to Dec. 31, 2019
- Imprinting formatMonth, day, year; Day, month, year; Year, month, day; Day, hour, min.; or blank
- Imprinting colorOrange
- Power sourceOne CR2025 lithium battery

- **Customize Function**13 Custom Functions with 34 settings

- **Power Source**

- BatteryTwo CR123A (or DL123A) lithium batteries
- Battery checkAuto (4-level indicator)
- Battery life

	Temperature	0% Flash Use	50% Flash Use	100% Flash Use
	At 20°C	125 (115) rolls	38 (33) rolls	19 (17) rolls
	At -20°C	70 (65) rolls	20 (19) rolls	10 (9) rolls

- With 24-ex. film. Figures in parentheses apply when Eye Control AF is turned on.

- LCD Panel illuminationProvided

- **Dimensions and Weight**

- Dimensions (W x H x D)146.7 x 103 x 69 mm / 5.78 x 4.06 x 2.72 in.
- Weight (body only)Eye Control/DATE model: 585 g / 20.6 oz
Eye Control/Non-DATE model: 580 g / 20.5 oz
Non-Eye Control/Non-DATE model: 575 g / 20.3 oz

- All the specifications above are based on Canon's testing and measuring standards.
- Specifications and external appearance are subject to change without notice.
- Asterisked items apply to Eye Control models only.

Index

A		E	
AE	89	E-TTL II autofocus	81
AE Lock.....	70, 92	Evaluative metering.....	52
AEB.....	68	Exposure	89
AF Mode	38	Exposure Compensation.....	67
AF Mode Dial	15	External flash	81
AF Point	41	Eye Control	43, 48
AF point selection key.....	16	Eye Control Switch.....	15
AF-Assist Beam	29	Eyecup	25, 34
AI Focus AF	40	Eyepiece Cover	34
AI Servo AF.....	39	F	
Aperture value.....	89	Film	22
Attaching the Strap	17	Film Advance Mode	73
A-TTL/TTL autofocus	81	Film advance mode lever	15
Automatic Selection	42	Flash Exposure Compensation.....	80
Av	58	Focus confirmation light.....	13
B		Focus lock	50
Basic Photography Terms	89	Full Auto	28
Basic zone.....	14	Function	11
Batteries.....	18	Function Availability Table	91
Battery Life.....	19	H	
Beeper.....	74	Handling Cautions.....	6
Built-in flash	78	Holding the Camera	26
Bulb Exposures.....	71	I	
C		Image zone	14
C.Fn	83	ISO film speed	73, 89
CAL	43	ISO Speed	73, 89
Calibration Procedure	43	L	
Center-weighted averaging metering...52		Landscape.....	30
Checking the Battery Level.....	19	LCD Panel.....	7, 12
Close-up.....	30	LCD Panel Illumination.....	74
Continuous shooting	73	Lens	20
Creative zone	14	M	
Custom Functions	83	M (Manual).....	60
D		Main Dial	16
Date/Time.....	35	Major Specifications.....	95
DEP.....	62	Manual Focusing.....	51
Depth-of-field	59, 90		
Dioptic Adjustment.....	25		

Manual Selection.....	42
Metering Modes	52
MF.....	20, 51
Midroll Rewind.....	24
Mirror Lockup	75
Mode Dial.....	14
Multiple exposures	72

N

Night Portrait	31
Nomenclature.....	10

O

One-Shot AF	39
-------------------	----

P

P (Program).....	54
Partial metering.....	52
Portrait.....	30
Predictive AF.....	40
Program AE.....	54
Program Line.....	93
Program Shift	55

Q

Quick Control Dial.....	16
Quick Start Guide.....	8

R

Red-eye Reduction	32
Remote Controller.....	76
Remote Switch	76
Replacing the Date Battery.....	36

S

Self-timer.....	33
Shooting modes	14
Shutter Button	
Halfway pressing.....	21
Full pressing.....	21
Shutter speed.....	89
Single-frame shooting	73
Speedlite	78, 81
Sports.....	31

T

Tv	56
----------	----

V

Viewfinder	13
------------------	----

W

Wireless Remote Control.....	76
------------------------------	----

This device complies with Part 15 of the FCC Rules. Operation is subject to the following two conditions: (1) This device may not cause harmful interference, and (2) this device must accept any interference received, including interference that may cause undesired operation.

Do not make any changes or modifications to the equipment unless otherwise specified in the instructions. If such changes or modifications should be made, you could be required to stop operation of the equipment.

This equipment has been tested and found to comply with the limits for a class B digital device, pursuant to part 15 of the FCC Rules. These limits are designed to provide reasonable protection against harmful interference in a residential installation. This equipment generates, uses and can radiate radio frequency energy and, if not installed and used in accordance with the instructions, may cause harmful interference to radio communications.

However, there is no guarantee that interference will not occur in a particular installation. If this equipment does cause harmful interference to radio or television reception, which can be determined by turning the equipment off and on, the user is encouraged to try to correct the interference by one or more of the following measures:

- Reorient or relocate the receiving antenna.
- Increase the separation between the equipment and receiver.
- Consult the dealer or an experienced radio/TV technician for help.

This digital apparatus does not exceed the Class B limits for radio noise emissions from digital apparatus as set out in the interference-causing equipment standard entitled "Digital Apparatus", ICES-003 of the Industry Canada.

Canon

CANON INC. 30-2, Shimomaruko 3-chome, Ohta-ku, Tokyo 146-8501, Japan

U.S.A. ————— **CANON U.S.A. INC.**

For all inquiries concerning this camera, call toll free in the U.S.
1-800-OK-CANON or write to: Customer Relations, Canon U.S.A., Inc.
One Canon Plaza, Lake Success, N.Y. 11042-1198

CANADA ————— **CANON CANADA INC. HEADQUARTERS**

6390 Dixie Road, Mississauga, Ontario L5T 1P7, Canada

CANON CANADA INC. MONTREAL BRANCH

5990, Côte-de-Liesse, Montréal Québec H4T 1V7, Canada

CANON CANADA INC. CALGARY OFFICE

2828, 16th Street, N.E. Calgary, Alberta T2E 7K7, Canada

For all inquiries concerning this camera, call toll free in Canada

1-800-OK-CANON

EUROPE, ————— **CANON EUROPA N.V.**

AFRICA & Bovenkerkerweg 59-61, P.O. Box 2262, 1180 EG Amstelveen,

MIDDLE EAST The Netherlands

CANON COMMUNICATION & IMAGE FRANCE S.A.

102, Avenue du Général de Gaulle 92257 La Garenne-Colombes Cedex, France

CANON UK LTD.

Woodhatch Reigate Surrey RH2 8BF, United Kingdom

CANON DEUTSCHLAND GmbH

Europark Fichtenhain A10, 47807 Krefeld, Germany

CANON ITALIA S.p.A.

Via Milano 8 I-20097 San Donato Milanese, Milano, Italy

CANON Schweiz AG

Geschäftsbereich Wiederverkauf, Industriestrasse 12, CH-8305 Dietlikon, Switzerland

CANON G. m. b. H.

Oberlaaerstrasse 233, 4th floor, 1100 Wien, Austria

CANON España, S. A.

C/Joaquín Costa, 41, 28002 Madrid, Spain

SEQUE Soc. Nac. de Equip., Lda.,

Praça da Alegria, 58, 2º, 1269-149 Lisboa, Portugal

CENTRAL & ————— **CANON LATIN AMERICA, INC. DEPTO DE VENTAS**

SOUTH AMERICA 703 Waterford Way Suite 400 Miami, FL 33126 U.S.A.

CANON LATIN AMERICA, INC. CENTRO DE SERVICIO Y REPARACION

Apartado 2019, Zona Libre de Colón, República de Panamá

ASIA ————— **CANON HONGKONG CO., LTD.**

9/F, The Hong Kong Club Building, 3A Chater Road, Central, Hong Kong

CANON SINGAPORE PTE. LTD.

79 Anson Road #09-01/06 Singapore 079906

OCEANIA ————— **CANON AUSTRALIA PTY. LTD.**

1 Thomas Holt Drive, North Ryde, N.S.W. 2113, Australia

CANON NEW ZEALAND LTD.

Akoranga Business Park, Akoranga Drive, Northcote, Auckland, New Zealand

JAPAN ————— **CANON SALES CO., INC.**

16-6, Kohnan 2-chome, Minato-ku, Tokyo 108-8011, Japan

This Instruction booklet is current as of December 2003. For information on using the camera with system accessories introduced after this date, contact your nearest Canon Service Center.